

SPEC. NO.: PS-51539-XXXXX

REVISION: C

PRODUCT NAME: 0.5 mm PITCH ZIF BACK FLIP FPC CONN.

SMT R/A D/C TYPE

PRODUCT NO: 51539 SERIES

PREPARED:	CHECKED:	APPROVED:
DATE: 2015/09/01	DATE: 2015/09/01	DATE: 2015/09/01

TITLE: 0.5 mm PITCH ZIF BACK FLIP FPC CONN. SMT R/A TYPE

RELEASE DATE: 2015/09/01

REVISION: C

ECN No: ECN-1509013

PAGE: 2 OF 13

1	REVISION HISTORY	3
2	SCOPE	4
3	APPLICABLE DOCUMENTS.....	4
4	REQUIREMENTS	4
5	PERFORMANCE	5
6	INFRARED REFLOW CONDITION	8
7	PRODUCT QUALIFICATION AND TEST SEQUENCE.....	9
8	CONNECTOR OPERATION.....	10

Aces P/N: **51539-XXXXX series**

TITLE: 0.5 mm PITCH ZIF BACK FLIP FPC CONN. SMT R/A TYPE

RELEASE DATE: 2015/09/01

REVISION: C

ECN No: ECN-1509013

PAGE: 3 OF 13

1 Revision History

Rev.	ECN #	Revision Description	Prepared	Date
1	ECN-1106105	NEW PROJECT SPEC FOR APD1000191	STANLEY	2011.06.07
O	ECN-1112070	NEW RELEASED	STANLEY	2011.12.07
A	ECN-1206422	MODIFIED CONNECTOR OPERATION	JAMELSEN	2012.06.21
B	ECN-1401128	ADD Working voltage	YANGYANG	2014/01/10
C	ECN-1509013	ADD CONNECTOR OPERATION	ZHOUQUAN	2015/09/01

TITLE: 0.5 mm PITCH ZIF BACK FLIP FPC CONN. SMT R/A TYPE

RELEASE DATE: 2015/09/01

REVISION: C

ECN No: ECN-1509013

PAGE: 4 OF 13

2 SCOPE

This specification covers performance, tests and quality requirements for 0.5 mm pitch ZIF back flip FPC CONN. SMT D/C R/A type.

3 APPLICABLE DOCUMENTS

EIA-364: ELECTRONICS INDUSTRIES ASSOCIATION

4 REQUIREMENTS

4.1 Design and Construction

- 4.1.1 Product shall be of design, construction and physical dimensions specified on applicable product drawing.
- 4.1.2 All materials conform to R.o.H.S. and the standard depends on TQ-WI-140101.

4.2 Materials and Finish

- 4.2.1 Contact: High performance copper alloy (Phosphor Bronze)
 - Finish: (a) Contact Area: Refer to the drawing.
 - (b) Under plate: Refer to the drawing.
 - (c) Solder area: Refer to the drawing.
- 4.2.2 Housing: Thermoplastic or Thermoplastic High Temp., UL94V-0
- 4.2.3 Actuator: Thermoplastic or Thermoplastic High Temp., UL94V-0
- 4.2.4 Fitting Nail: Copper Alloy, Finish: Refer to the drawing.

4.3 Ratings

- 4.3.1 Working voltage less than 36 volts AC (per pin)
- 4.3.2 Voltage: 50 Volts AC (per pin)
- 4.3.3 Current: DC 0.5 Amperes (per pin)
- 4.3.4 Operating Temperature : -40°C to +85°C

TITLE: 0.5 mm PITCH ZIF BACK FLIP FPC CONN. SMT R/A TYPE

RELEASE DATE: 2015/09/01

REVISION: C

ECN No: ECN-1509013

PAGE: 5 OF 13

5 Performance

5.1. Test Requirements and Procedures Summary

Item	Requirement	Standard
Examination of Product	Product shall meet requirements of applicable product drawing and specification.	Visual, dimensional and functional per applicable quality inspection plan.
ELECTRICAL		
Item	Requirement	Standard
Low Level Contact Resistance	60 m Ω Max. (initial) per contact 20 m Ω Max. Change allowed	Mate connectors, measure by dry circuit, 20mV Max., 100mA (EIA-364-23)
Insulation Resistance	500 M Ω Min.	Unmated connectors, apply 100 V DC between adjacent terminals. (EIA-364-21)
Dielectric Withstanding Voltage	No discharge, flashover or breakdown. Current leakage: 1 mA max.	200 VAC Min. at sea level for 1 minute. Test between adjacent contacts of unmated connectors. (EIA-364-20)
Temperature rise	30°C Max. Change allowed	Mate connector: measure the temperature rise at rated current until temperature stable. The ambient condition is still air at 25°C (EIA-364-70 METHOD 1, CONDITION 1)

TITLE: 0.5 mm PITCH ZIF BACK FLIP FPC CONN. SMT R/A TYPE

RELEASE DATE: 2015/09/01

REVISION: C

ECN No: ECN-1509013

PAGE: 6 OF 13

MECHANICAL		
Item	Requirement	Standard
Durability	20 cycles.	The sample should be mounted in the tester and fully mated and unmated the number of cycles specified at the rate of 25.4 ± 3mm/min. (EIA-364-09)
FPC Retention Force (Without Lock)	15 gf/pin MIN.	Apply axial pull out force at the speed rate of 25.4 ± 3 mm/minute.
Terminal / Housing Retention Force	50 gf MIN.	Apply axial pull out force at the speed rate of 25.4 ± 3 mm/minute. On the terminal assembled in the housing.
Fitting Nail /Housing Retention Force	50 gf MIN.	Apply axial pull out force at the speed rate of 25.4 ± 3 mm/minute. On the fitting nail assembled in the housing.
Vibration	1 μs Max.	The electrical load condition shall be 100 mA maximum for all contacts. Subject to a simple harmonic motion having amplitude of 0.76mm (1.52mm maximum total excursion) in frequency between the limits of 10 and 55 Hz. The entire frequency range, from 10 to 55 Hz and return to 10 Hz, shall be traversed in approximately 1 minute. This motion shall be applied for 2 hours in each of three mutually perpendicular directions. (EIA-364-28 Condition I)
Shock (Mechanical)	1 μs Max.	Subject mated connectors to 50 G's (peak value) half-sine shock pulses of 11 milliseconds duration. Three shocks in each direction shall be applied along the three mutually perpendicular axes of the test specimen (18 shocks). The electrical load condition shall be 100mA maximum for all contacts. (EIA-364-27, test condition A)

TITLE: 0.5 mm PITCH ZIF BACK FLIP FPC CONN. SMT R/A TYPE

RELEASE DATE: 2015/09/01

REVISION: C

ECN No: ECN-1509013

PAGE: 7 OF 13

ENVIRONMENTAL

Item	Requirement	Standard
Resistance to Reflow Soldering Heat	See Product Qualification and Test Sequence Group 10 (Lead Free) No deformation of components affecting performance.	Pre Heat : 150°C~180°C, 60~120sec. Heat : 230°C Min., 40sec Min. Peak Temp. : 260°C Max, 10sec Max. Cycles : 2
Hand Soldering Temperature Resistance	Appearance: No damage	T ≥ 350°C, 3sec at least
Thermal Shock	See Product Qualification and Test Sequence Group 4	Mate module and subject to follow condition for 5 cycles. 1 cycles: -55 +/-3 °C, 30 minutes +85 +/-3 °C, 30 minutes (EIA-364-32, test condition I)
Humidity	See Product Qualification and Test Sequence Group 4	Mated Connector 40°C, 90~95% RH, 96 hours. (EIA-364-31, Condition A, Method II)
Temperature life	See Product Qualification and Test Sequence Group 5	Subject mated connectors to temperature life at 85°C for 96 hours. (EIA-364-17, Test condition A)
Salt Spray (Only For Gold Plating)	See Product Qualification and Test Sequence Group 6	Subject mated/unmated connectors to 5% salt-solution concentration, 35°C (I) Gold flash for 8 hours (II) Gold plating 5 u" for 96 hours. (EIA-364-26)
Solder ability	Tin plating: Solder able area shall have minimum of 95% solder coverage. Gold plating: Solder able area shall have minimum of 75% solder coverage.	And then into solder bath, Temperature at 245 ±5°C, for 4-5 sec. (EIA-364-52)

Note. Flowing Mixed Gas shall be conducted by customer request.

6 INFRARED REFLOW CONDITION

Lead-free Process

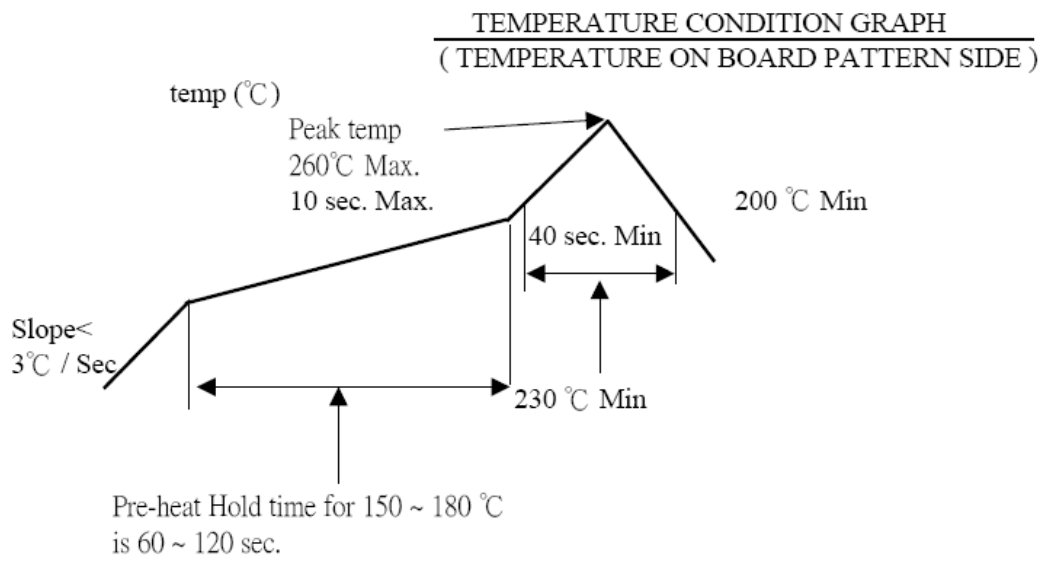

TITLE: 0.5 mm PITCH ZIF BACK FLIP FPC CONN. SMT R/A TYPE

RELEASE DATE: 2015/09/01

REVISION: C

ECN No: ECN-1509013

PAGE: 9 OF 13

7 PRODUCT QUALIFICATION AND TEST SEQUENCE

Test or Examination	Test Group									
	1	2	3	4	5	6	7	8	9	10
	Test Sequence									
Examination of Product				1、7	1、6	1、4			1	1
Low Level Contact Resistance		1、3	1、4	2、10	2、9	2、5			3	
Insulation Resistance				3、9	3、8					
Dielectric Withstanding Voltage				4、8	4、7					
Temperature rise	1									
Durability		2								
Vibration			2							
Shock (Mechanical)			3							
Thermal Shock				5						
Humidity				6						
Temperature life					5					
Salt Spray(Only For Gold Plating)						3				
Solder ability							1			
Terminal / Housing Retention Force								1		
Fitting Nail /Housing Retention Force								2		
Resistance to Soldering Heat									2	
Hand Soldering Temperature Resistance										2
Sample Size	2	4	4	4	4	4	2	4	4	4

8 Connector Operation

Exercise care when handling connectors. Follow recommendations given below.

- A. Please open and close the actuator with the connector is mounted on the P.C.Board, and the FPC inserted. The actuator might not come off from the opening and shutting of the actuator in the state that FPC is not inserted and do not do, please.

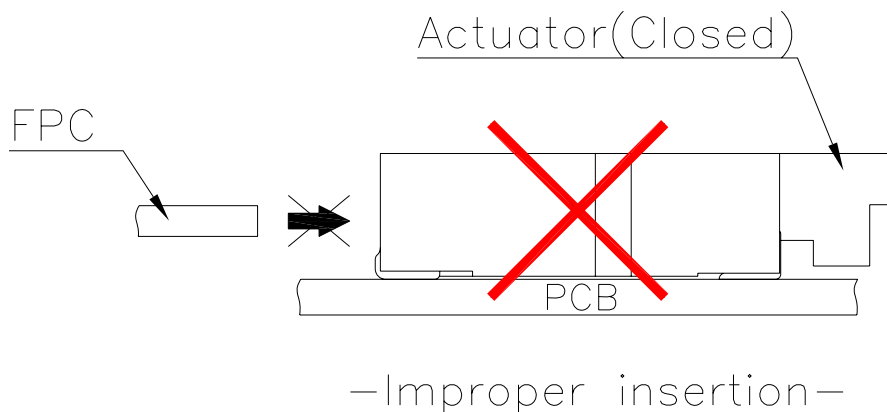
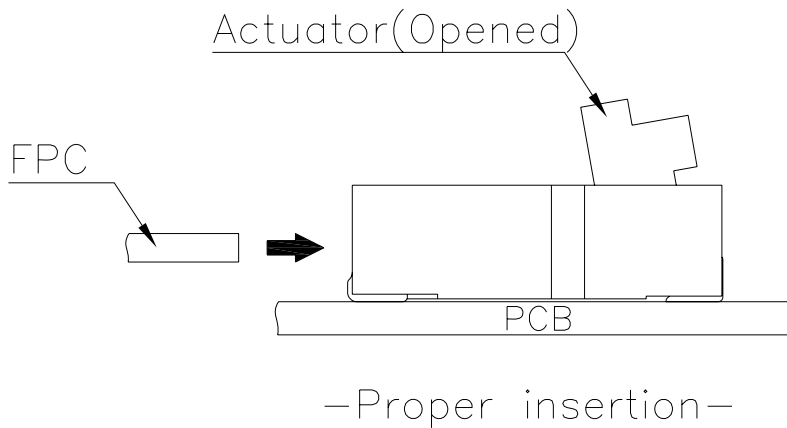

- B. Try to insert with horizontal manner when FPC inserted into the product, allowed maximum insertion angle is 6°.

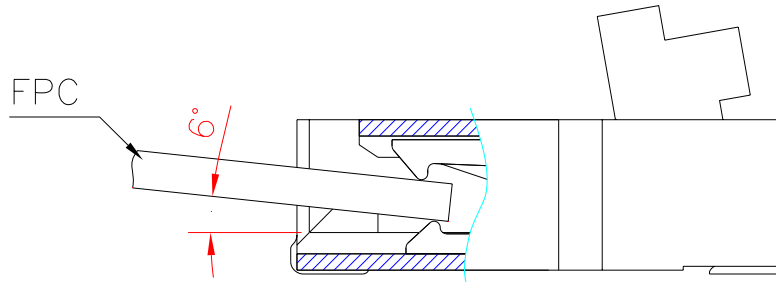

- C. FPC Correct insertion verification

A visual comparison of the edge of the housing opening and the FPC pattern boundary will prevent diagonal insertion and partial insertion errors.

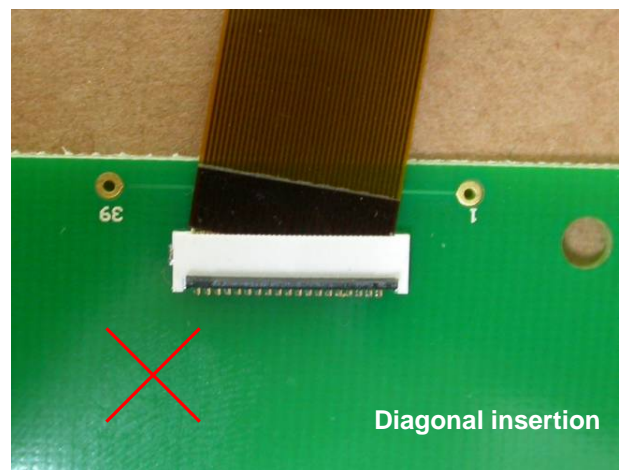
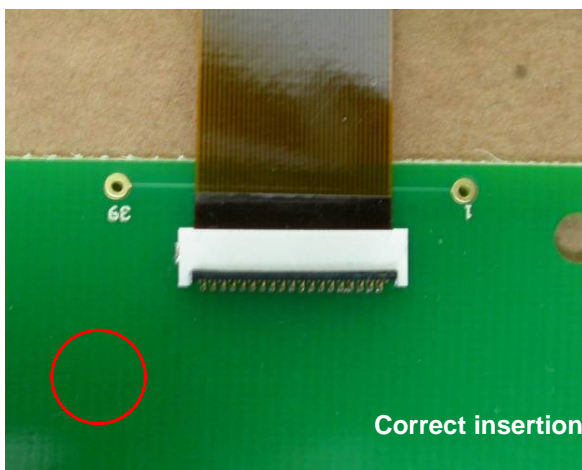

D. Locking

After FPC/FFC insertion, push center of the actuator and make it completed down.

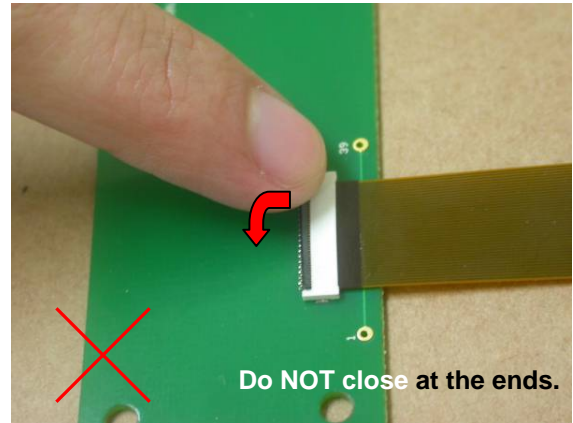
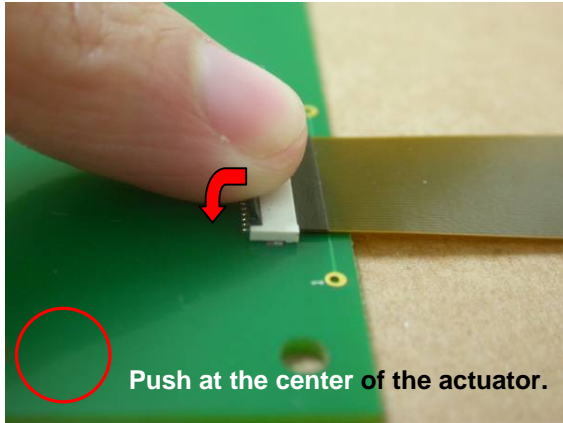

Make surface between actuator and housing be horizontal, it's correct lock position.

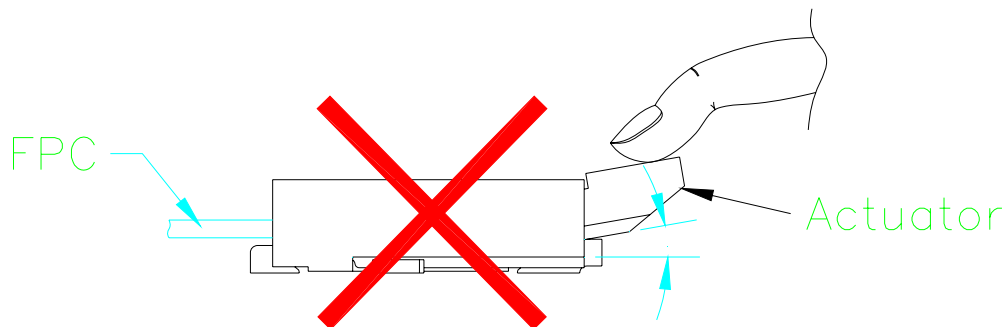
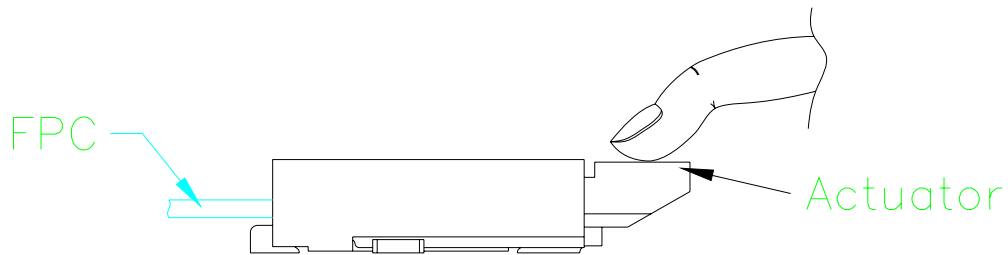

E. Lock release

Carefully rotate the actuator up to 90°, lifting it at the center.

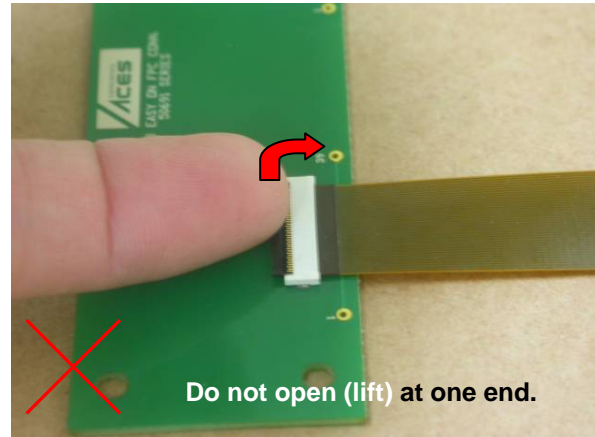
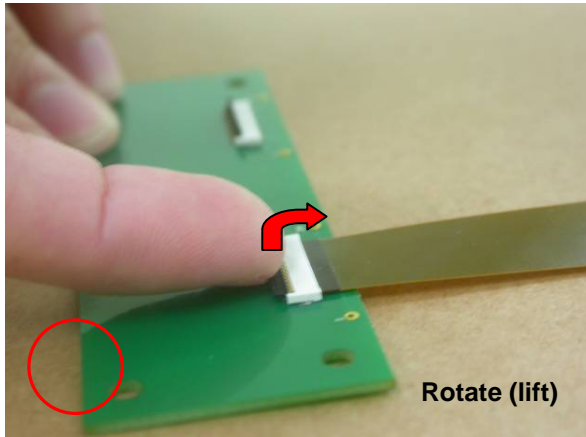

- The actuator opens by rotating it in the direction OPPOSITE to the direction of the insertion of the FPC. DO NOT attempt to open it from the same side as the insertion of the FPC.

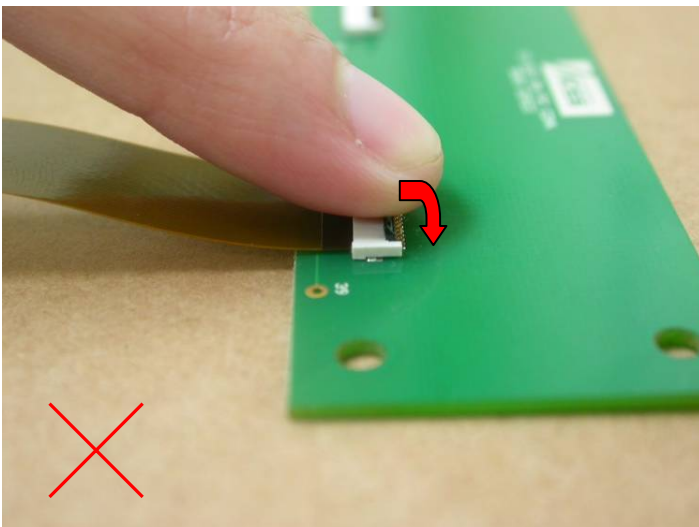

Precautions

F. This connector is small and thin and requires delicate and careful handling.

Be very careful not to apply any force to the FPC after inserting it.

Otherwise, the connector may become unlocked or the FPC may break.

Fix the FPC, in particular, when loads are applied to it continuously.

Design the FPC layout with care not to bend it sharply near the insertion opening.

