

RS2AB

Surface Mount Glass Passivated Fast Rectifiers
Reverse Voltage 50V Forward Current 2.0A

1. FEATURES

- We declare that the material of product compliance with RoHS requirements and Halogen Free.
- Plastic package has Underwriters Laboratory Flammability Classification 94V-0.
- High temperature metallurgically bonded construction.
- Cavity-free glass passivated junction.
- Capable of meeting environmental standards of MIL-S-19500.
- Fast Switching for high efficiency
- Typical IR less than 1.0 μ A.
- High temperature soldering guaranteed:260°C/10 seconds.
- Weight: 0.088g

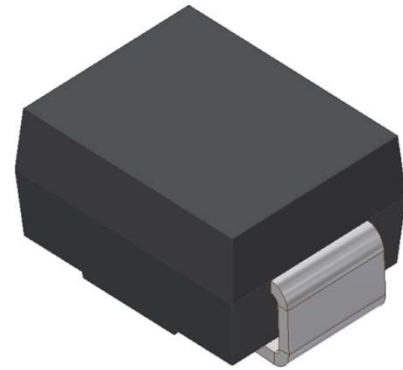

2. DEVICE MARKING AND ORDERING INFORMATION

Device	Marking	Shipping
RS2AB	RS2A	4000/Tape&Reel

3. MAXIMUM RATINGS(Ta = 25°C)

Parameter	Symbol	Limits	Unit
Maximum repetitive peak reverse voltage	VRRM	50	V
Maximum RMS voltage	VRMS	35	V
Maximum DC blocking voltage	VDC	50	V
Maximum average forward rectified current 0.375" (9.5mm) lead length at TC = 75°C	IF(AV)	2	A
Peak forward surge current 8.3ms single half sine-wave superimposed on rated load (JEDEC Method)	IFSM	50	A
Typical thermal resistance (Note 1)	R θ JA	160	°C/W
	R θ JC	50	
Operating junction and storage temperature range	TJ, TSTG	-50 ~+150	°C

4. ELECTRICAL CHARACTERISTICS (Ta= 25°C)

Characteristic	Symbol	Min.	Typ.	Max.	Unit
Maximum instantaneous forward voltage at 2.0A	VF	-	-	1.3	V
Maximum DC reverse current TA = 25°C at rated DC blocking voltage TJ = 125°C	IR	-	-	5 100	μ A
Typical reverse recovery time (Note 2)	trr	-	-	150	ns
Typical junction capacitance at 4.0V, 1MHz	CJ	-	30	-	PF

1. 8.0mm² (.013mm thick) land areas
2. IF = 0.5A, IR = 1.0A, IRR = 0.25A

5. ELECTRICAL CHARACTERISTICS CURVES

Fig. 1 - Forward Current Derating Curve

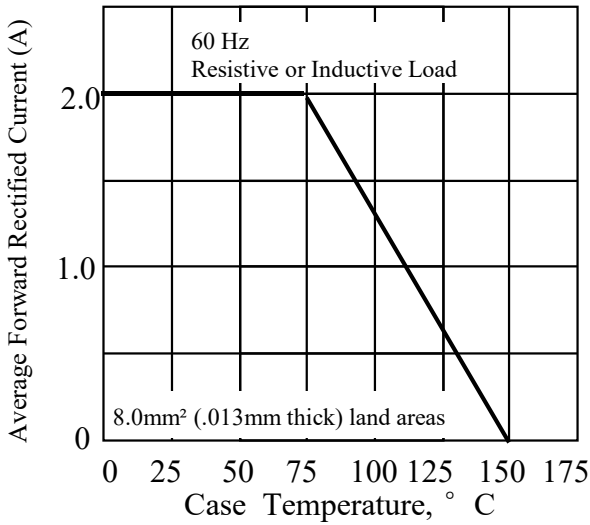

Fig. 2 - Maximum Non-repetitive Peak Forward Surge Current

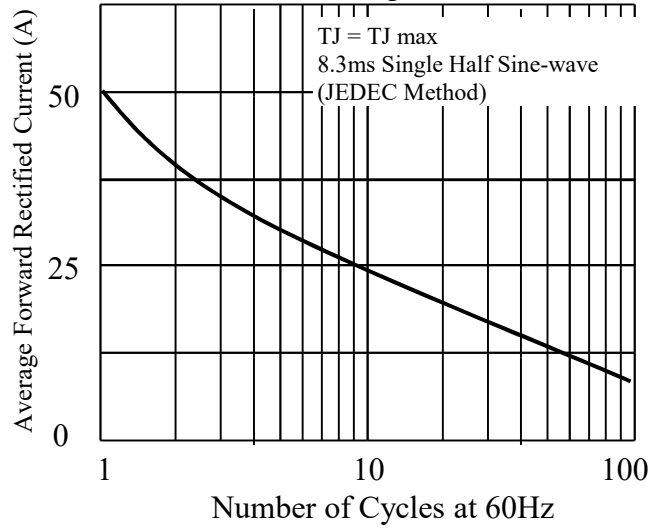

Fig 3. - Typical Instantaneous Forward Characteristics

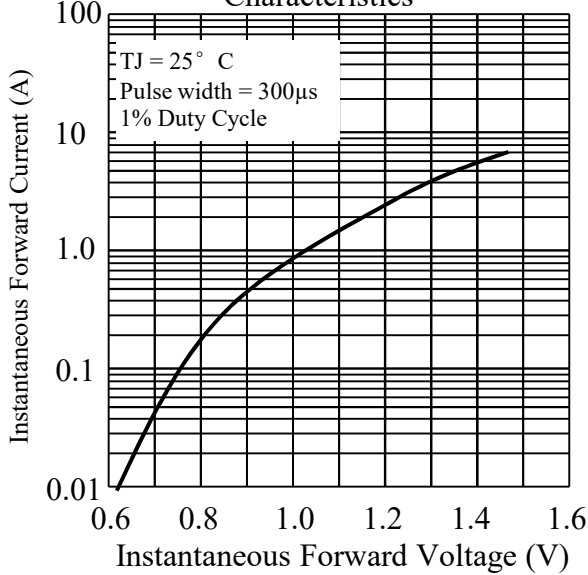

Fig 4. - Typical Reverse Characteristics

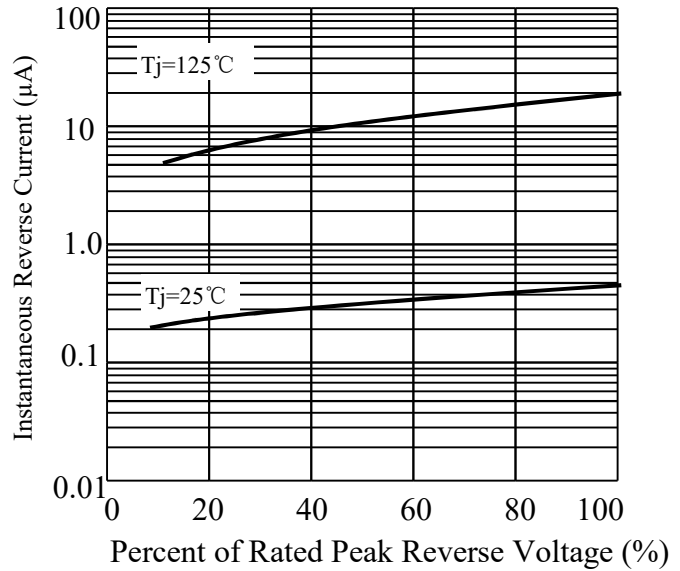
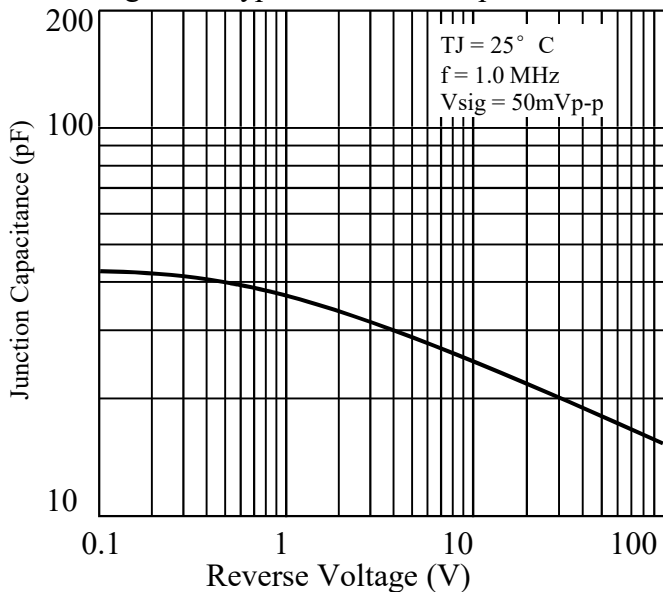
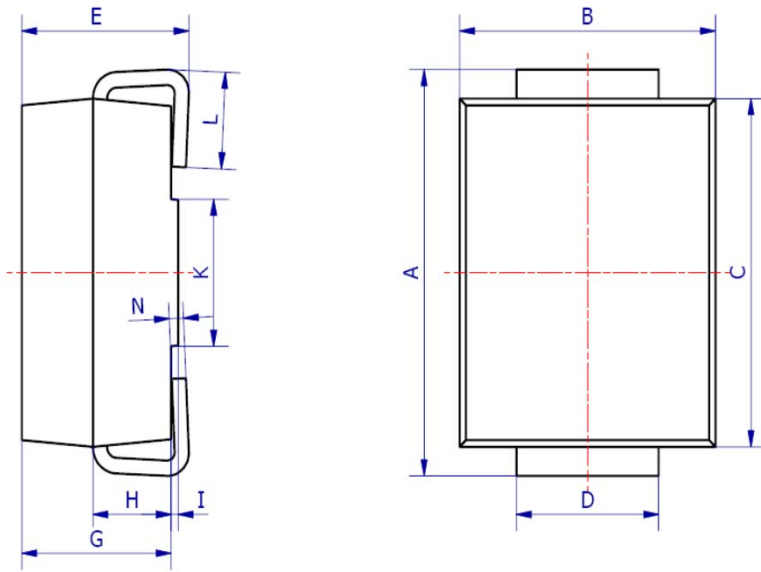

Fig 5. - Typical Junction Capacitance



6. OUTLINE AND DIMENSIONS



SMB			
DIM	Min	Max	Typ.
A	5.20	5.45	5.25
B	3.20	4.00	3.60
C	4.30	4.60	4.50
D	1.80	2.20	2.00
E	2.20	2.50	2.35
G	1.90	2.30	2.10
H	0.95	1.25	1.10
I	0.05	0.15	0.10
K	1.70	2.10	1.90
L	1.00	1.50	1.30
N	0.10	0.30	0.20
All Dimensions in mm			

7. SOLDERING FOOTPRINT

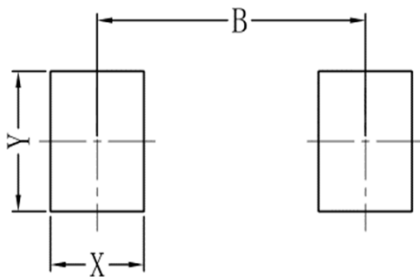

SMB	
DIM	(mm)
X	1.60
Y	2.20
B	4.60