

# S-SM10200C

Surface Mount Schottky Barrier Rectifiers  
Reverse Voltage 200V Forward Current 10.0A

## 1. FEATURES

- We declare that the material of product compliance with RoHS requirements and Halogen Free.
- Plastic package has Underwriters Laboratory Flammability Classification 94V-0.
- Low power loss,high efficiency.
- For use in low voltage high frequency inverters,free wheeling, and polarity protection applications.
- High temperature soldering guaranteed:260°C/10 seconds.
- Weight: 0.26g
- S- prefix for automotive and other applications requiring unique site and control change requirements; AEC-Q101 qualified and PPAP capable.



## 2. DEVICE MARKING AND ORDERING INFORMATION

Device	Marking	Shipping
S-SM10200C	S-SM10200C	3000/Tape&Reel

## 3. MAXIMUM RATINGS(Ta = 25°C)

Parameter	Symbol	Limits	Unit
Maximum repetitive peak reverse voltage	VRRM	200	V
Maximum RMS voltage	VRMS	140	V
Maximum DC blocking voltage	VDC	200	V
Maximum average forward rectified current at TC = 75°C	IF(AV)	10	A
Peak forward surge current 8.3ms single half sine-wave superimposed on rated load (JEDEC Method)	IFSM	200	A
Typical thermal resistance (Note 1)	RθJA	80	°C/W
	RθJC	20	
Operating junction and storage temperature range	TJ, TSTG	-50 ~+150	°C

## 4. ELECTRICAL CHARACTERISTICS (Ta= 25°C)

Characteristic	Symbol	Min.	Typ.	Max.	Unit
Maximum instantaneous forward voltage at 5.0A	VF	-	-	0.85	V
Maximum DC reverse current TA = 25°C at rated DC blocking voltage TJ = 125°C	IR	-	-	5 1000	uA
Typical junction capacitance at 4.0V, 1MHz	CJ	-	250	-	PF

1. Mounted on 0.31 x 0.31" (8.0 x 8.0mm) copper pads to each terminal
2. IF = 0.5A, IR = 1.0A, IRR = 0.25A

**5. ELECTRICAL CHARACTERISTICS CURVES**

Fig. 1 - Forward Current Derating Curve

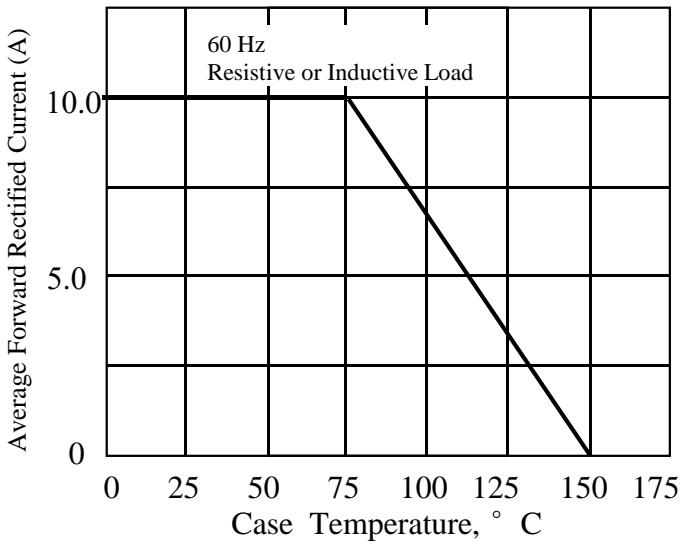

Fig. 2 - Maximum Non-repetitive Peak Forward Surge Current

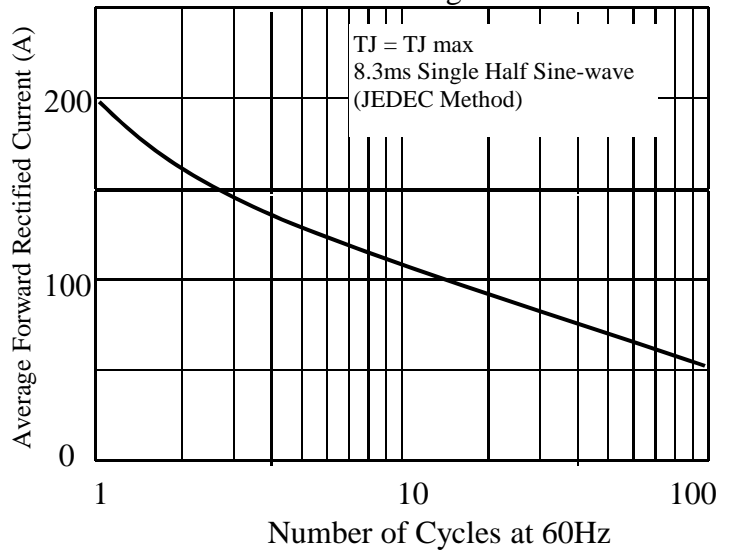

Fig 3. - Typical Instantaneous Forward Characteristics

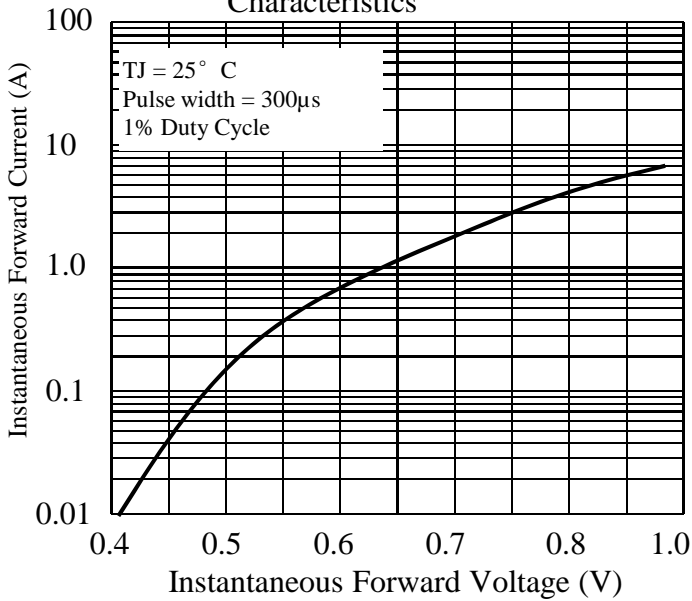

Fig 4. - Typical Reverse Characteristics

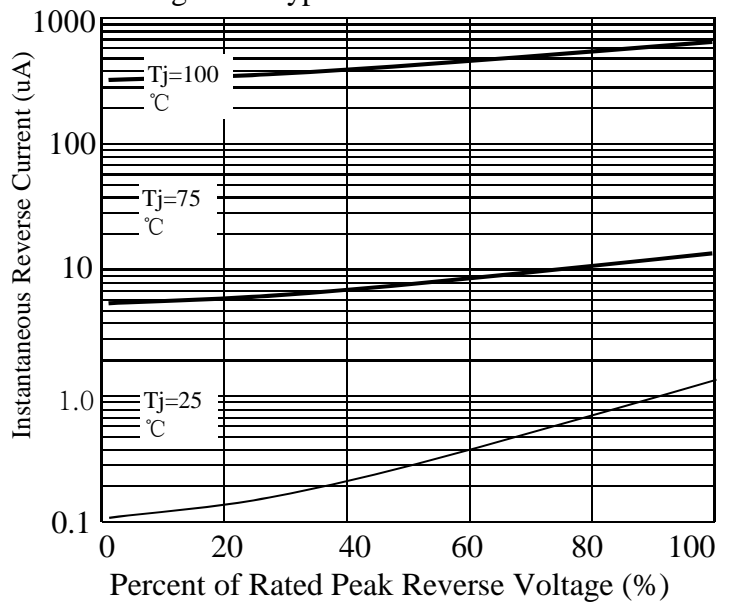
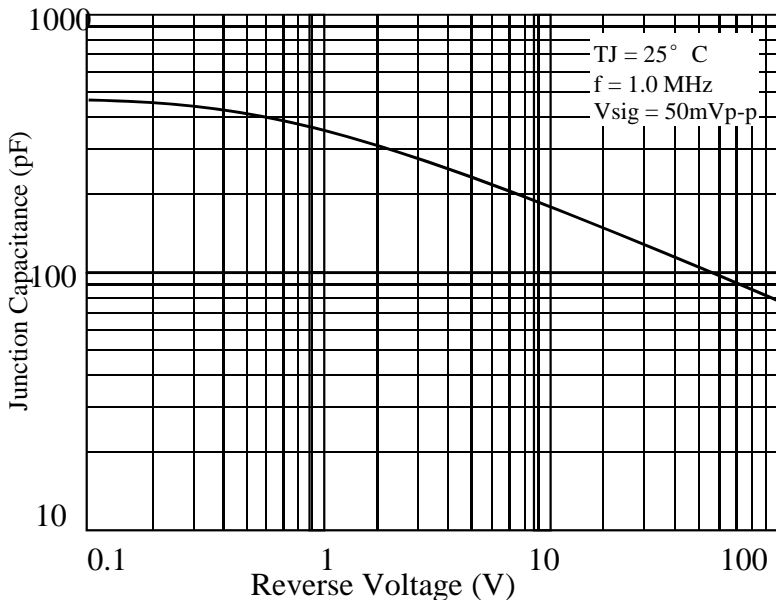
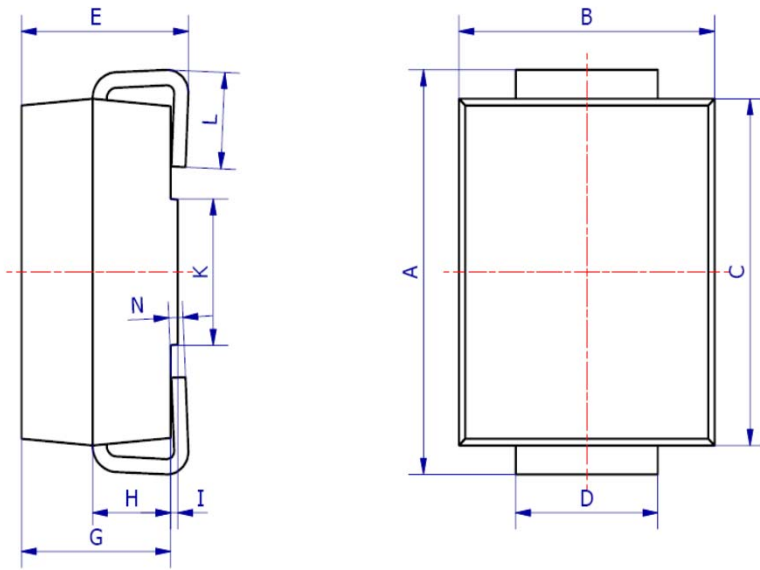

Fig 5. - Typical Junction Capacitance



## 6. OUTLINE AND DIMENSIONS



SMC			
DIM	Min	Max	Typ.
A	7.70	8.30	8.00
B	5.85	6.25	6.05
C	6.65	7.05	6.85
D	2.80	3.20	3.00
E	2.45	2.85	2.65
G	2.10	2.50	2.30
H	1.00	1.40	1.20
I	0.05	0.15	0.10
K	4.30	4.70	4.50
L	1.00	1.50	1.25
N	0.10	0.30	0.20
All Dimensions in mm			

## 7. SOLDERING FOOTPRINT

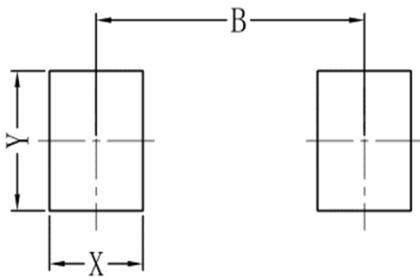

SMC	
DIM	(mm)
X	1.60
Y	3.30
B	6.60