

## TO-92 Plastic-Encapsulate Transistors

### MPSA29 TRANSISTOR (NPN)

#### FEATURES

- Darlington Transistor

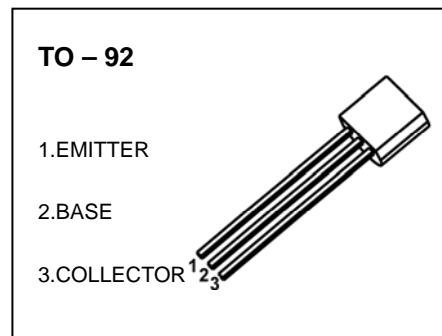

#### MARKING

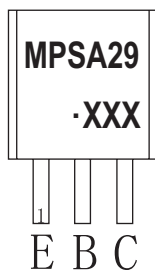

MPSA29=Device code  
 Solid dot= Green molding compound device, if none, the normal device  
 XXX=Code

#### Equivalent Circuit

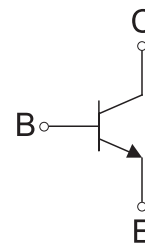

#### ORDERING INFORMATION

Part Number	Package	Packing Method	Pack Quantity
MPSA29	TO-92	Bulk	1000pcs/Bag
MPSA29-TA	TO-92	Tape	2000pcs/Box

#### MAXIMUM RATINGS ( $T_a=25^{\circ}\text{C}$ unless otherwise noted)

Symbol	Parameter	Value	Unit
$V_{CBO}$	Collector-Base Voltage	100	V
$V_{CES}$	Collector-Emitter Voltage	100	V
$V_{EBO}$	Emitter-Base Voltage	12	V
$I_C$	Collector Current	0.5	A
$P_C$	Collector Power Dissipation	625	mW
$R_{\theta JA}$	Thermal Resistance From Junction To Ambient	200	$^{\circ}\text{C}/\text{W}$
$T_J, T_{stg}$	Operation Junction and Storage Temperature Range	-55~+150	$^{\circ}\text{C}$

## ELECTRICAL CHARACTERISTICS

$T_a=25\text{ }^\circ\text{C}$  unless otherwise specified

Parameter	Symbol	Test conditions	Min	Typ	Max	Unit
Collector-base breakdown voltage	$V_{(BR)CBO}$	$I_C=0.1\text{mA}, I_E=0$	100			V
Collector-emitter breakdown voltage	$V_{(BR)CES}$	$I_C=0.1\text{mA}, V_{BE}=0$	100			V
Emitter-base breakdown voltage	$V_{(BR)EBO}$	$I_E=10\mu\text{A}, I_C=0$	12			V
Collector cut-off current	$I_{CBO}$	$V_{CB}=80\text{V}, I_E=0$			0.1	$\mu\text{A}$
Collector cut-off current	$I_{CES}$	$V_{CE}=80\text{V}, I_E=0$			0.5	$\mu\text{A}$
Emitter cut-off current	$I_{EBO}$	$V_{EB}=10\text{V}, I_C=0$			0.1	$\mu\text{A}$
DC current gain	$h_{FE(1)}$ *	$V_{CE}=5\text{V}, I_C=10\text{mA}$	10000			
	$h_{FE(2)}$ *	$V_{CE}=5\text{V}, I_C=100\text{mA}$	10000			
Collector-emitter saturation voltage	$V_{CE(sat)(1)}$ *	$I_C=10\text{mA}, I_B=0.01\text{mA}$			1.2	V
	$V_{CE(sat)(2)}$ *	$I_C=100\text{mA}, I_B=0.1\text{mA}$			1.5	V
Base-emitter voltage	$V_{BE}$ *	$V_{CE}=5\text{V}, I_C=100\text{mA}$			2.0	V
Transition frequency	$f_T$	$V_{CE}=5\text{V}, I_C=10\text{mA}, f=100\text{MHz}$	125			MHz
Collector output capacitance	$C_{ob}$	$V_{CB}=10\text{V}, I_E=0, f=1\text{MHz}$			8	pF

\*Pulse test: pulse width  $\leq 300\mu\text{s}$ , duty cycles  $\leq 2.0\%$ .

# Typical Characteristics

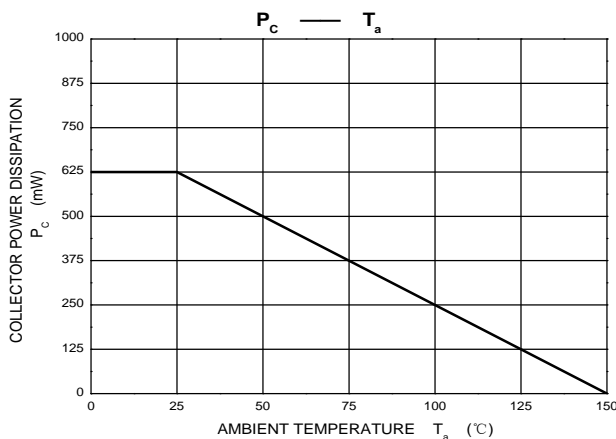
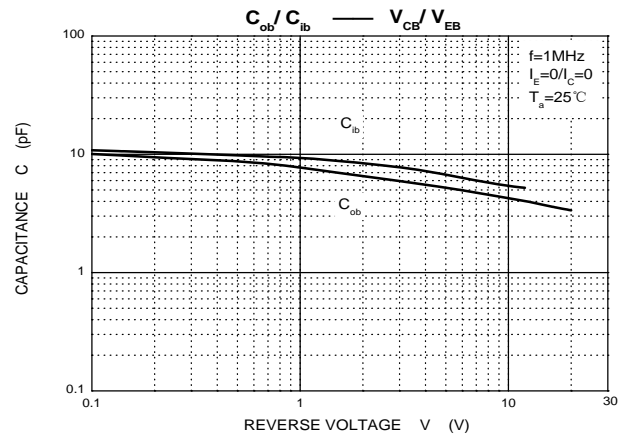
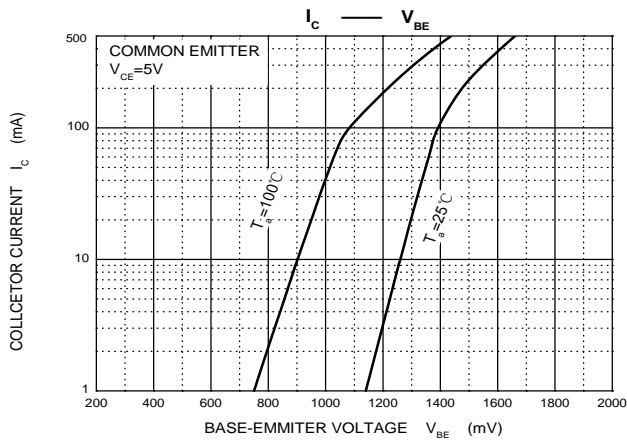
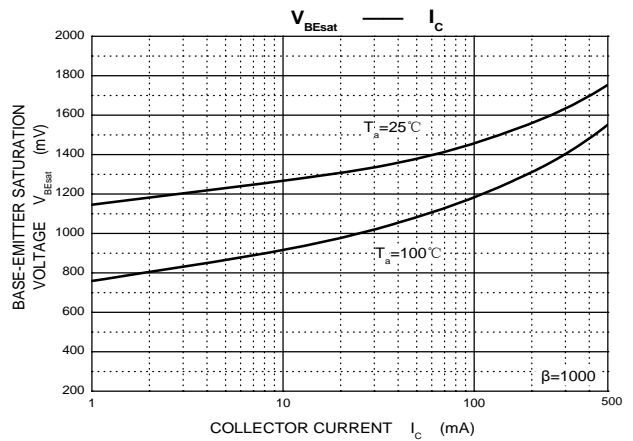
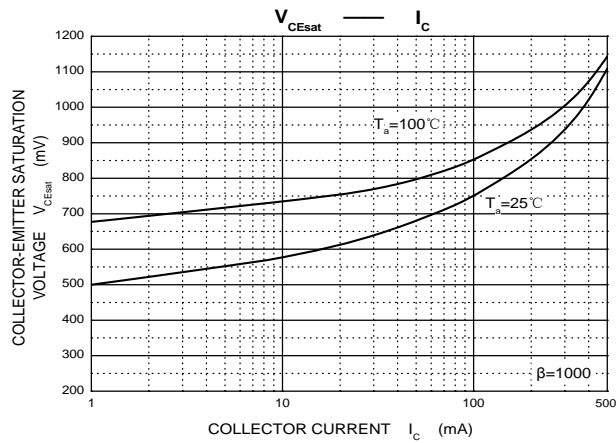
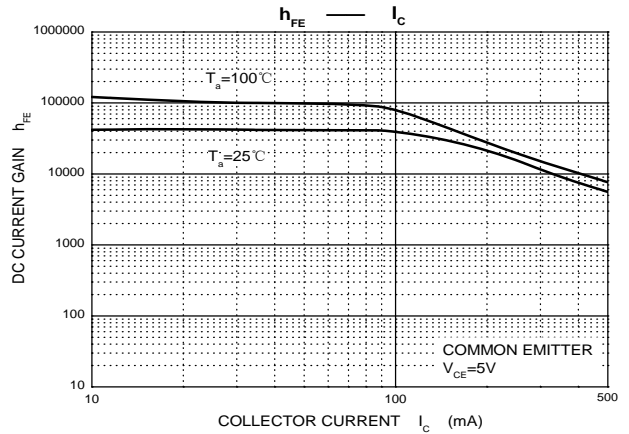
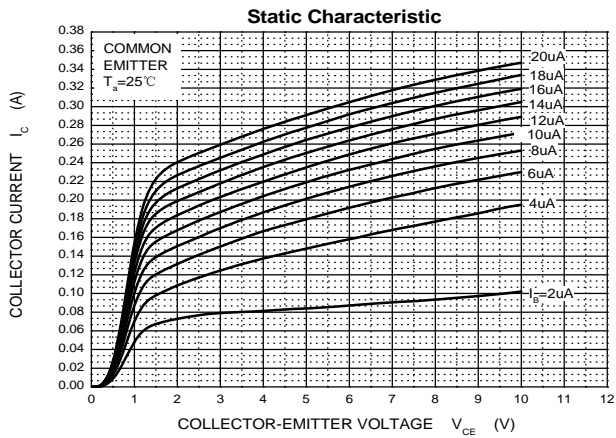

## TO-92 Package Outline Dimensions

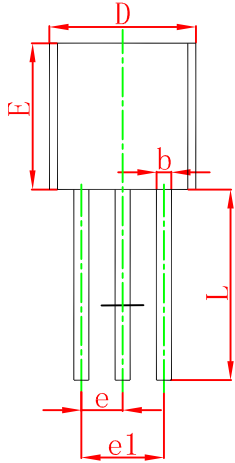

Symbol	Dimensions In Millimeters		Dimensions In Inches	
	Min	Max	Min	Max
A	3.300	3.700	0.130	0.146
A1	1.100	1.400	0.043	0.055
b	0.380	0.550	0.015	0.022
c	0.360	0.510	0.014	0.020
D	4.300	4.700	0.169	0.185
D1	3.430		0.135	
E	4.300	4.700	0.169	0.185
e	1.270 TYP		0.050 TYP	
e1	2.440	2.640	0.096	0.104
L	14.100	14.500	0.555	0.571
Φ		1.600		0.063
h	0.000	0.380	0.000	0.015

## TO-92 Suggested Pad Layout

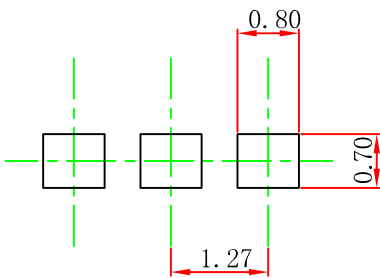

### Note:

1. Controlling dimension: in millimeters.
2. General tolerance:  $\pm 0.05\text{mm}$ .
3. The pad layout is for reference purposes only.

### NOTICE

JSCJ reserves the right to make modifications, enhancements, improvements, corrections or other changes without further notice to any product herein. JSCJ does not assume any liability arising out of the application or use of any product described herein.

TO-92 PACKAGE TAPING DIMENSION

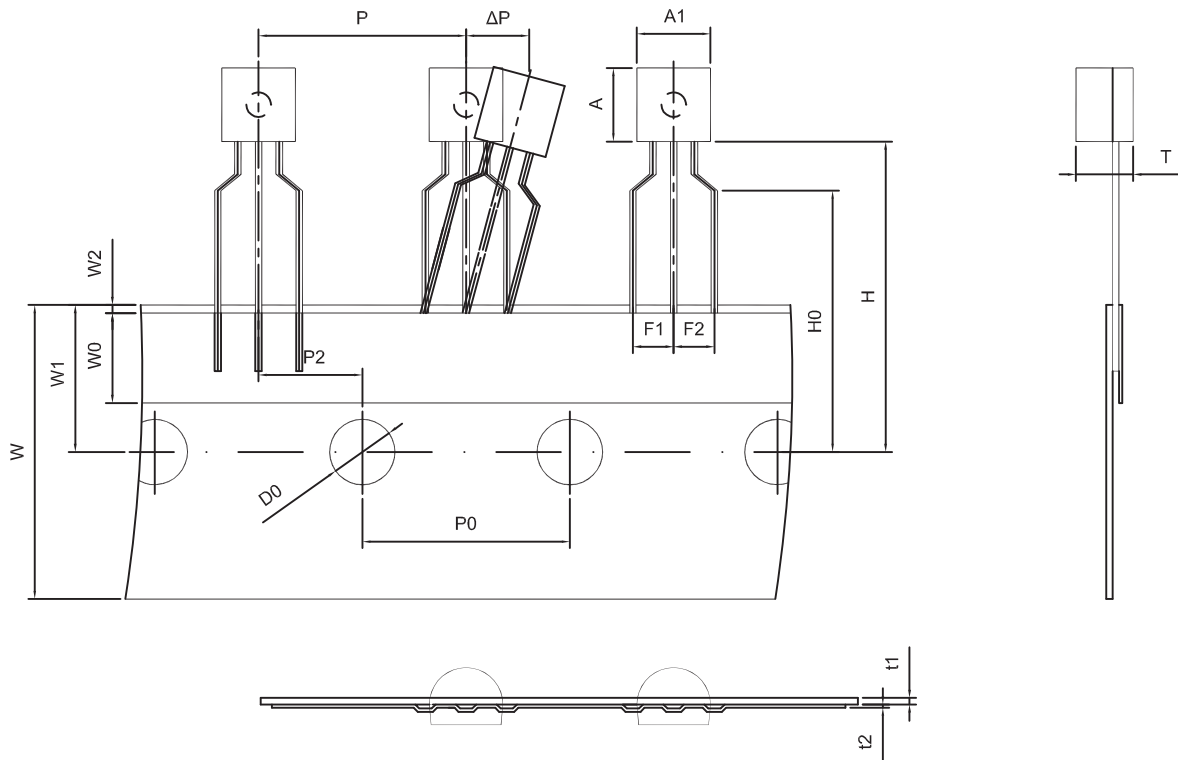

Dimensions are in millimeter								
A1	A	T	P	P0	P2	F1	F2	W
4.5	4.5	3.5	12.7	12.7	6.35	2.5	2.5	18.0
W0	W1	W2	H	H0	D0	t1	t2	ΔP
6.0	9.0	1.0 MAX.	19.0	16.0	4.0	0.4	0.2	0

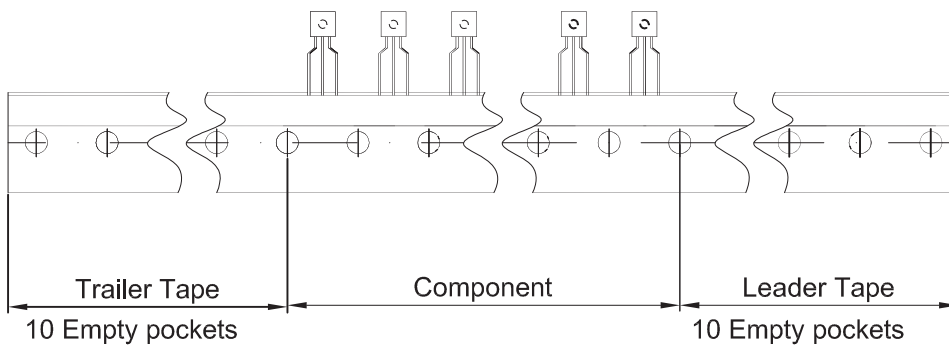

Package	Box	Box Size(mm)	Carton	Carton Size(mm)
TO-92	2000 pcs	333×162×43	20,000 pcs	350×340×250