

SOT-523 Plastic-Encapsulate Diodes

BAS40T/-04T/-05T/-06T SCHOTTKY BARRIER DIODE

SOT-523

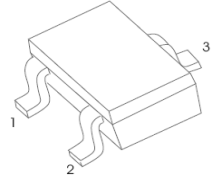

FEATURES

- Low forward voltage
- Fast switching

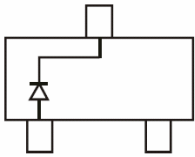

BAS40T MARKING: 43

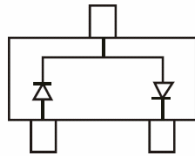

BAS40-04T MARKING: 44

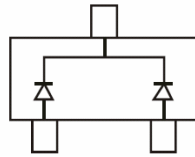

BAS40-05T MARKING: 45

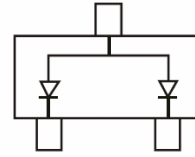

BAS40-06T MARKING: 46

MARKING:

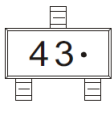
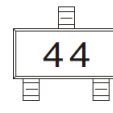
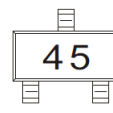
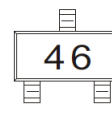
BAS40T	BAS40-04T	BAS40-05T	BAS40-06T
			

Maximum Ratings @Ta=25°C

Parameter	Symbol	Limit	Unit
Peak Repetitive Peak Reverse Voltage	V_{RRM}	40	V
Working Peak Reverse Voltage	V_{RWM}		
DC Blocking Voltage	V_R		
Forward Continuous Current	I_{FM}	200	mA
Average Rectified Output Current	I_O	200	mA
Non-Repetitive Peak Forward Surge Current @ t = 8.3ms	I_{FSM}	0.6	A
Power Dissipation	P_D	150	mW
Thermal Resistance Junction to Ambient	$R_{\theta JA}$	667	°C/W
Operating Junction Temperature Range	T_J	-40 ~ +125	°C
Storage Temperature Range	T_{STG}	-55 ~ +150	°C

Electrical Characteristics @Ta=25°C

Parameter	Symbol	Min	Typ	Max	Unit	Conditions
Reverse Breakdown Voltage	$V_{(BR)}$	40			V	$I_R=10\mu A$
Forward Voltage	V_{F1}			0.38	V	$I_F=1mA$
	V_{F2}			1	V	$I_F=40mA$
Reverse Current	I_R			0.2	μA	$V_R=30V$
Diode Capacitance	C_D			5	pF	$V_R=0, f=1MHz$
Reverse Recovery Time	t_{rr}			5	ns	$I_F=I_R=10mA$ $I_{rr}=0.1I_R, R_L=100\Omega$

Typical Characteristics

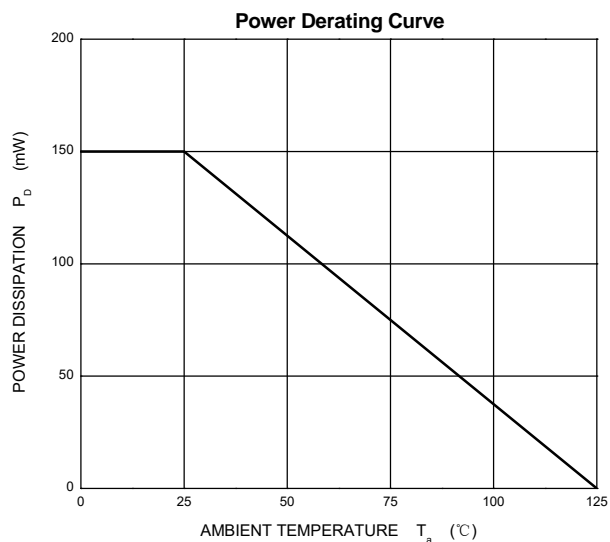
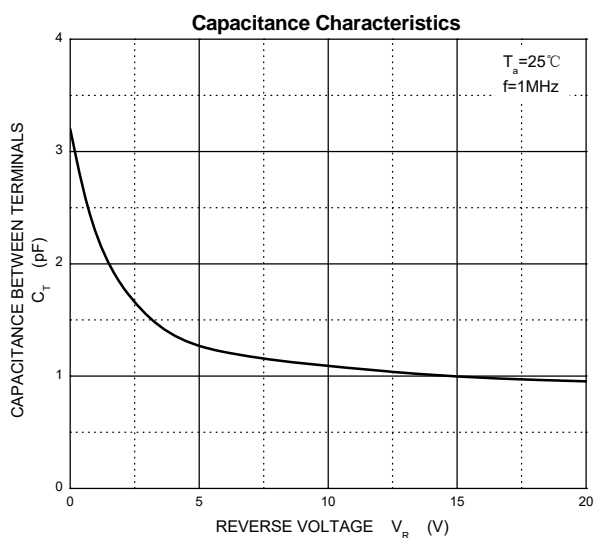
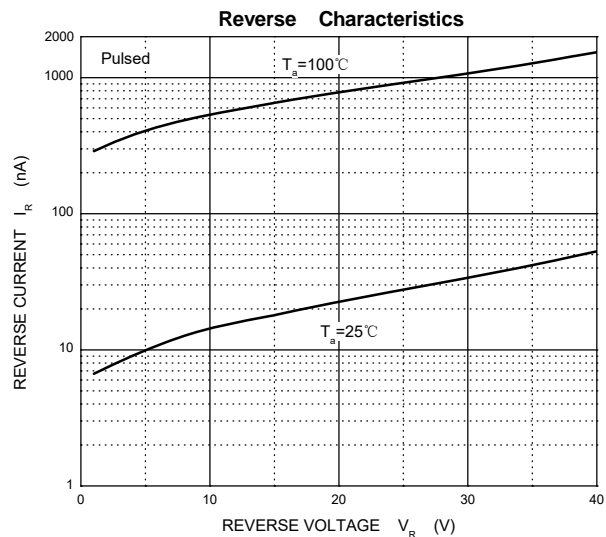
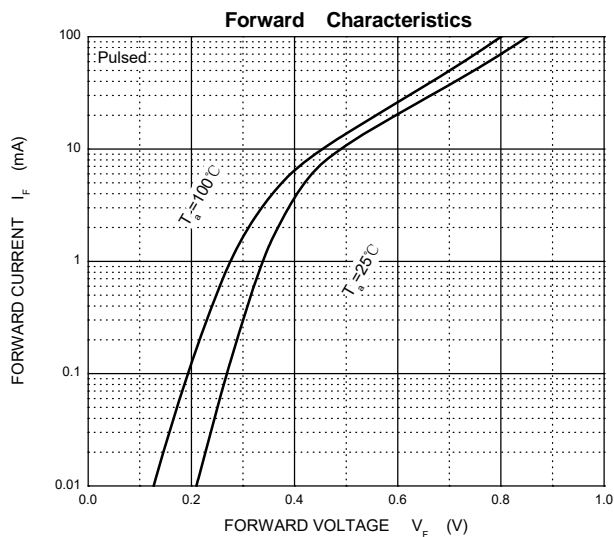

SOT-523 Package Outline Dimensions

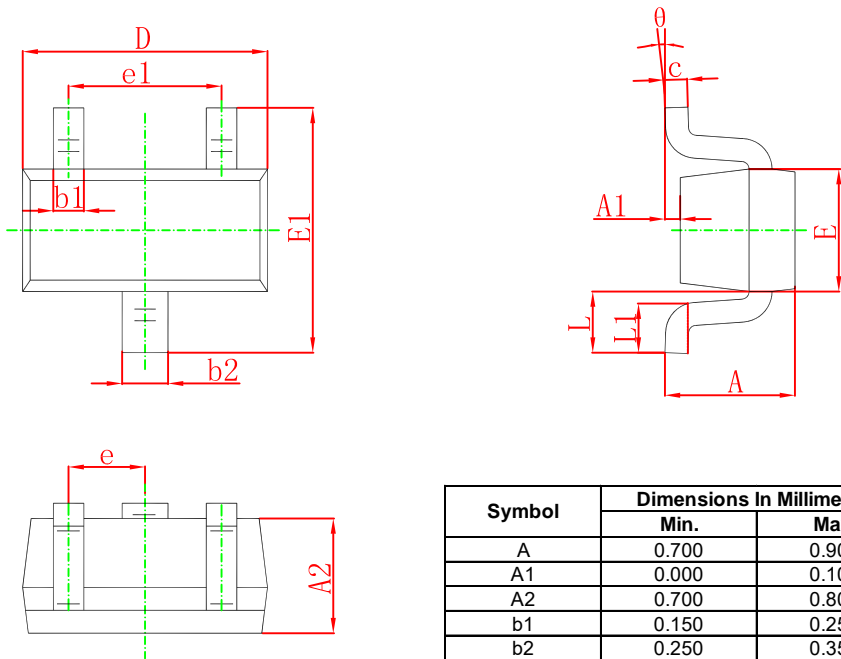

Symbol	Dimensions In Millimeters		Dimensions In Inches	
	Min.	Max.	Min.	Max.
A	0.700	0.900	0.028	0.035
A1	0.000	0.100	0.000	0.004
A2	0.700	0.800	0.028	0.031
b1	0.150	0.250	0.006	0.010
b2	0.250	0.350	0.010	0.014
c	0.100	0.200	0.004	0.008
D	1.500	1.700	0.059	0.067
E	0.700	0.900	0.028	0.035
E1	1.450	1.750	0.057	0.069
e	0.500 TYP.		0.020 TYP.	
e1	0.900	1.100	0.035	0.043
L	0.400 REF.		0.016 REF.	
L1	0.260	0.460	0.010	0.018
theta	0°	8°	0°	8°

SOT-523 Suggested Pad Layout



- Note:
1. Controlling dimension: in millimeters.
 2. General tolerance: ± 0.05 mm.
 3. The pad layout is for reference purposes only.

NOTICE

JSCJ reserves the right to make modifications, enhancements, improvements, corrections or other changes without further notice to any product herein. JSCJ does not assume any liability arising out of the application or use of any product described herein.

SOT-523 Tape and Reel

SOT-523 Embossed Carrier Tape

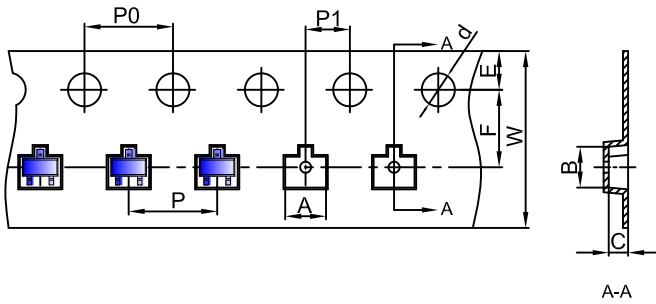

Packaging Description:

SOT-523 parts are shipped in tape. The carrier tape is made from a dissipative (carbon filled) polycarbonate resin. The cover tape is a multilayer film (Heat Activated Adhesive in nature) primarily composed of polyester film, adhesive layer, sealant, and anti-static sprayed agent. These reeled parts in standard option are shipped with 3,000 units per 7" or 17.8cm diameter reel. The reels are clear in color and is made of polystyrene plastic (anti-static coated).

Dimensions are in millimeter

Pkg type	A	B	C	d	E	F	P0	P	P1	W
SOT-523	1.85	1.85	0.875	Ø1.50	1.75	3.50	4.00	4.00	2.00	8.00

SOT-523 Tape Leader and Trailer

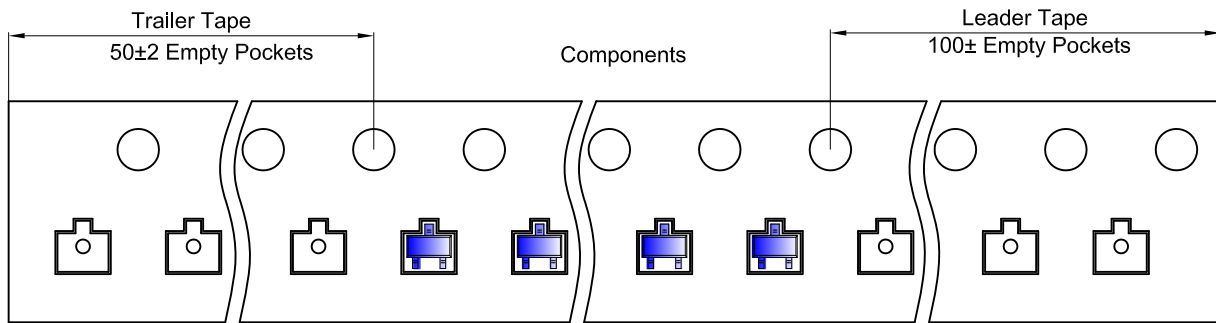

SOT-523 Reel

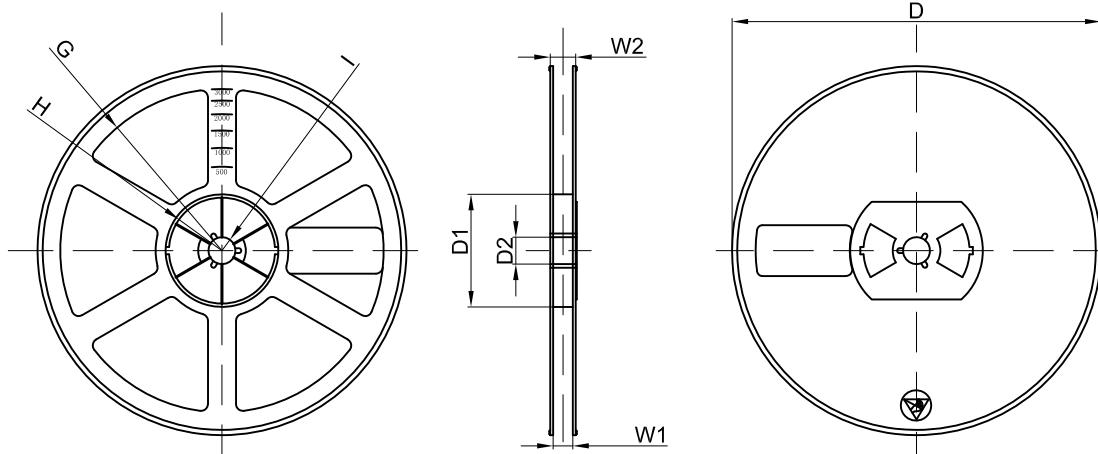

Dimensions are in millimeter

Reel Option	D	D1	D2	G	H	I	W1	W2
7"Dia	Ø178.00	54.40	13.00	R78.00	R25.60	R6.50	9.50	12.30

REEL	Reel Size	Box	Box Size(mm)	Carton	Carton Size(mm)	G.W.(kg)
3000 pcs	7 inch	45,000 pcs	203×203×195	180,000 pcs	438×438×220	