



Automotive High-speed Differential Transmission
Compatible Connector

MX49A Series

CONNECTOR

MB-0292-1

April 2015

Angle Pin Connector

Socket Connector

In-line Connector



Along with the electronic advances taking place in cars, the use of displays is rapidly growing due to the safety checks using surround view systems and LCD type instrument panels, and DVD watching in the rear seat.

And the transmission signals are shifting to digital high-speed differential transmission, which can transmit large amounts of data more efficiently.

To meet these demands, MX49A has been developed to add to our line-up for automotive high-speed differential LVDS / GVIF compatible connectors.

Features

- Compatible with automotive LVDS / GVIF digital image signal transmission. (GVIF is a trademark of Sony Corporation.)
- Impedance matching design, compatible with high-speed transmission.
- Whole surface of connector is covered with a shield shell for EMI control.
- 4 positions: one channel for signal (2pos.) with power and ground or two channels for signal.
- 5 types of mis-mating prevention keys are available.
- Available as a completed harness to ensure transmission performance reliability.

General Specifications

- | | |
|--|---------------------------------------|
| ■ No. of Contacts: 4 pos. | ■ Applicable Wire: 4 cores |
| ■ Operating Temperature Range:
-40 Deg. C to +85 Deg. C | Quad shielded twisted cable |
| ■ Insulation Resistance: 100M ohms min. | ■ Connector Insertion Force: 70N max. |
| ■ Dielectric Withstanding Voltage:
AC1000Vr.m.s,
applied for 1 minute (When mated) | |
| ■ Applicable Board Thickness: 1.6mm | |

Materials and Finishes

Angle Pin Connector

Component	Material and Finish
Shell, ground terminal	Copper alloy / Sn plating
Housing	SPS-GF30
Terminal	Copper alloy / Contact area: Au plating Terminal area: Sn plating

Note: Please consult us concerning packaging.

Socket Connector

Component	Material and Finish
Sleeve, ground shell	Brass or copper alloy / Sn plating
Housing	PBT or LCP-GF35
Terminal	Copper alloy / Contact area: Au plating Terminal area: Sn plating

In-line Connector

Component	Material and Finish
Sleeve, ground shell	Brass or copper alloy / Sn plating
Housing	PBT or LCP-GF35
Terminal	Copper alloy / Connection area: Au plating Terminal area: Sn plating

Outer Dimensions

Angle Pin Connector (MX49A04NQ1) Drawing: SJ111705

Unit: mm

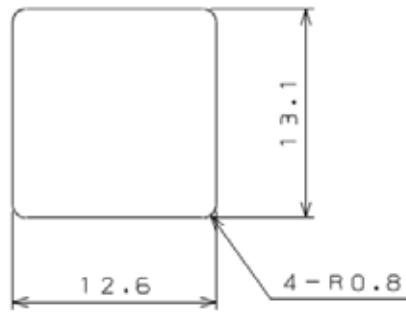
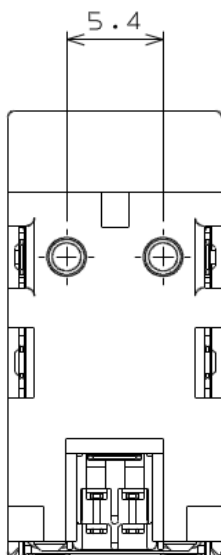
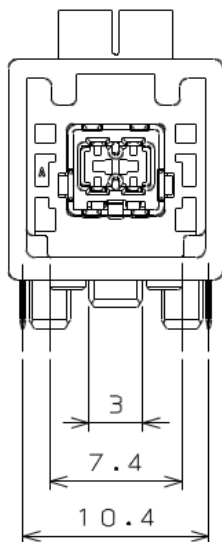
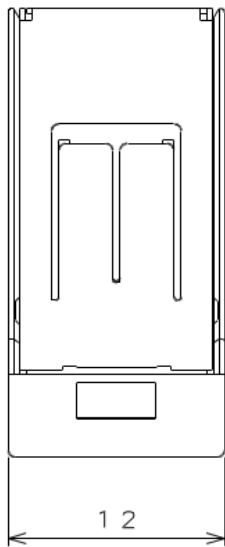

PANEL CUT OUT DIMENSION (REF.)

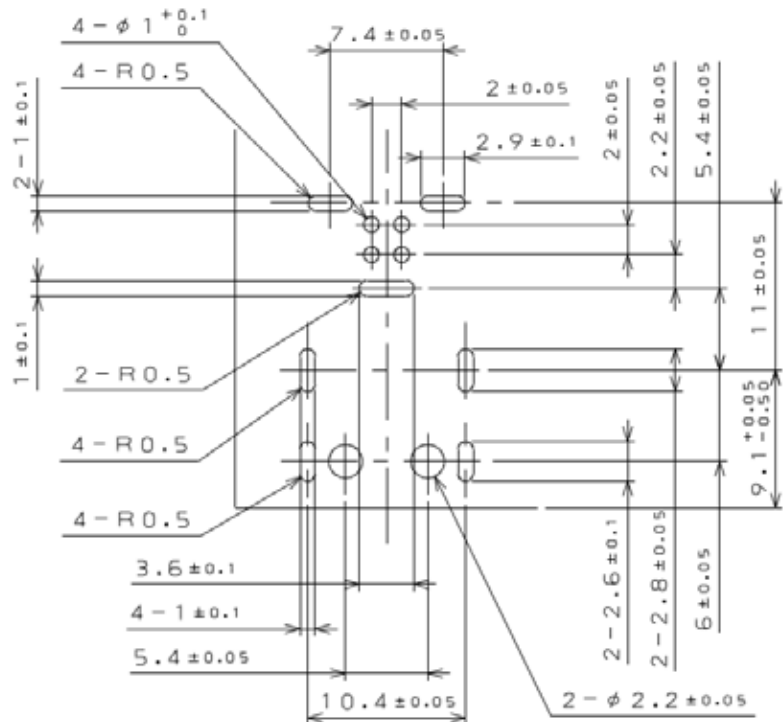
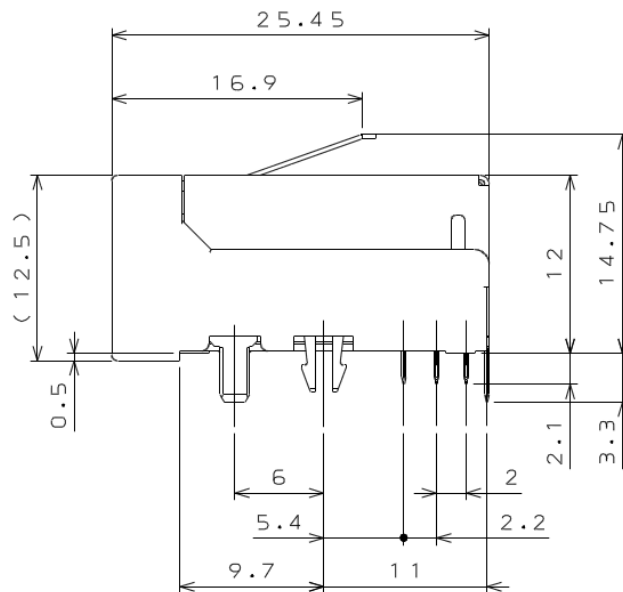

APPLICABLE P.C.B. DIMENSION (REF.)

Outer Dimensions

Socket Connector (for reference)

Unit: mm

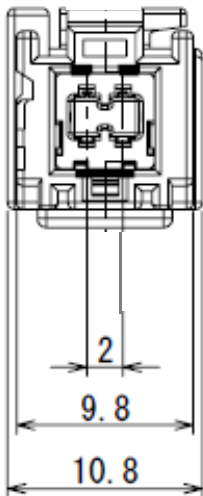
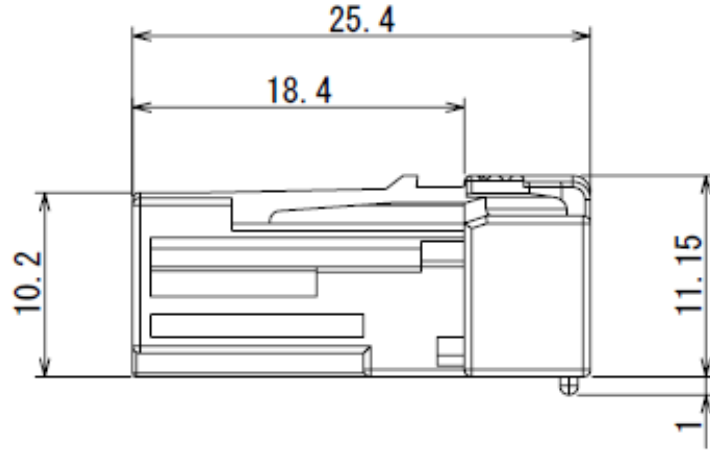
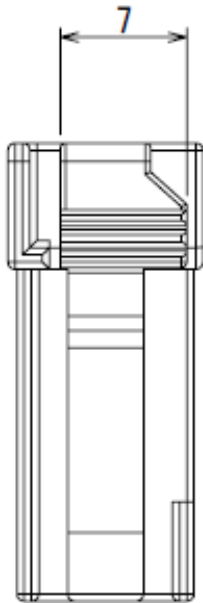

Note: The socket connector is to be sold as a harnessed product. It is not available as an individual connector.

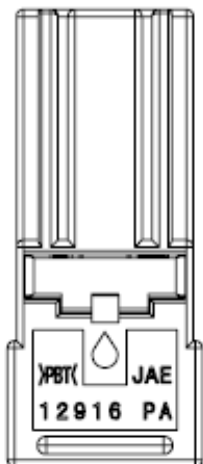

Outer Dimensions

In-line connector (for reference)

Unit: mm

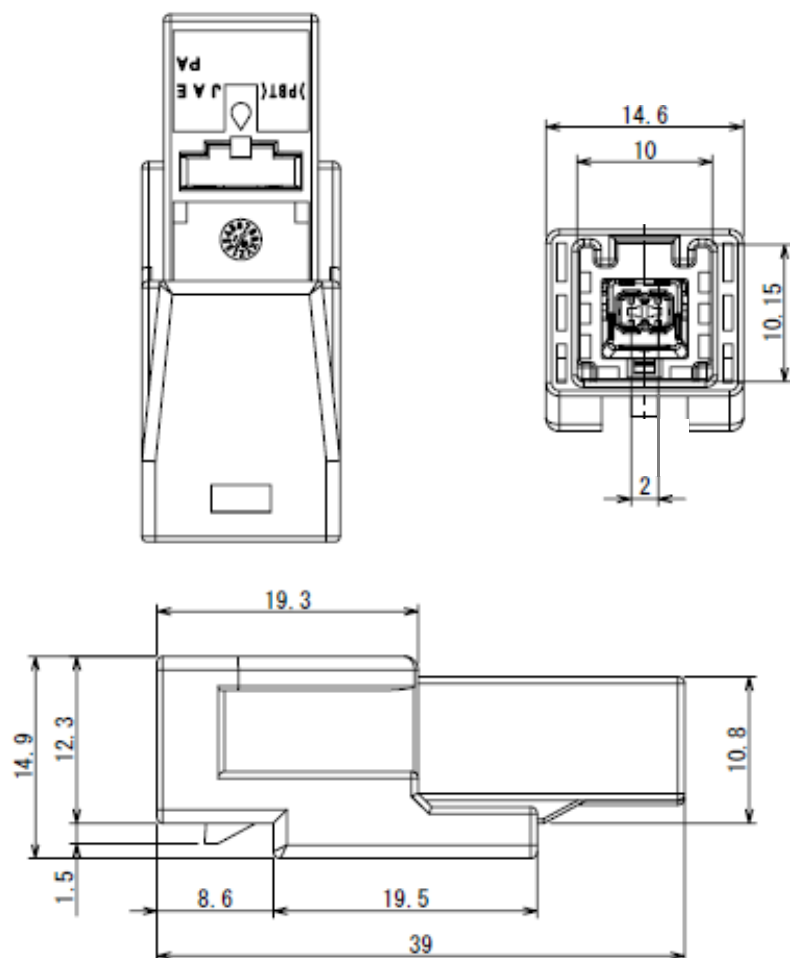

Note: The in-line connector is to be sold as a harnessed product. It is not available as an individual connector.

Others

Specifications:
JACS-10793

Notice:

1. The values specified in this brochure are only for reference. The products and their specifications are subject to change without notice. Contact our sales staff for further information before considering or ordering any of our products. For purchase, a product specification must be agreed upon.

2. Users are requested to provide protection circuits and redundancy circuits to ensure safety of the equipment, and sufficiently review the suitability of JAE's products to the equipment.

3. The products presented in this brochure are designed for the uses recommended below.

We strongly suggest you contact our sales staff when considering use of any of the products in any other way than the recommended applications or for a specific use that requires an extremely high reliability.

(1) Applications that require consultation:

(i) Please contact us if you are considering use involving a quality assurance program that you specify or that is peculiar to the industry, such as:

Automotive electrical components, train control, telecommunications devices (mainline), traffic light control, electric power, combustion control, fire prevention or security systems, disaster prevention equipment, etc.

(ii) We may separately give you our support with a quality assurance program that

you specify, when you think of a use such as :

Aviation or space equipment, submarine repeaters, nuclear power control systems, medical equipment for life support, etc.

(2) Recommended applications include:

Computers, office appliances, telecommunications devices (terminals, mobile units), measuring equipment, audiovisual equipment, home electric appliances, factory automation equipment, etc

Japan Aviation Electronics Industry, Limited

* The specifications in this brochure are subject to change without notice. Please contact JAE for information.