



LIGHTING FOREVER

Technical Data Sheet

5484BN/Y7DC-AHJB/P/MS

Features

- High luminous intensity output
- Oval Shape
- Well defined spatial radiation
- Wide viewing angle ($2\theta_{1/2}$) : $110^\circ / 40^\circ$
- UV resistant epoxy
- The product itself will remain within RoHS compliant version.

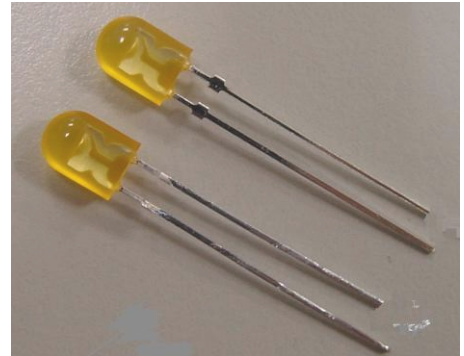

Descriptions

- This precision optical performance oval LED is specifically designed for passenger information signs
- This lamp has matched radiation patterns with yellow, blue or green mixing color applications

Applications

- Color graphic signs
- Message boards
- Variable message signs (VMS)
- Commercial outdoor advertising

Device Selection Guide

Chip		Lens Color
Material	Emitted Color	
AlGaInP	Brilliant Yellow	Yellow Diffused



LIGHTING FOREVER

Technical Data Sheet

5484BN/Y7DC-AHJB/P/MS

Package Dimensions

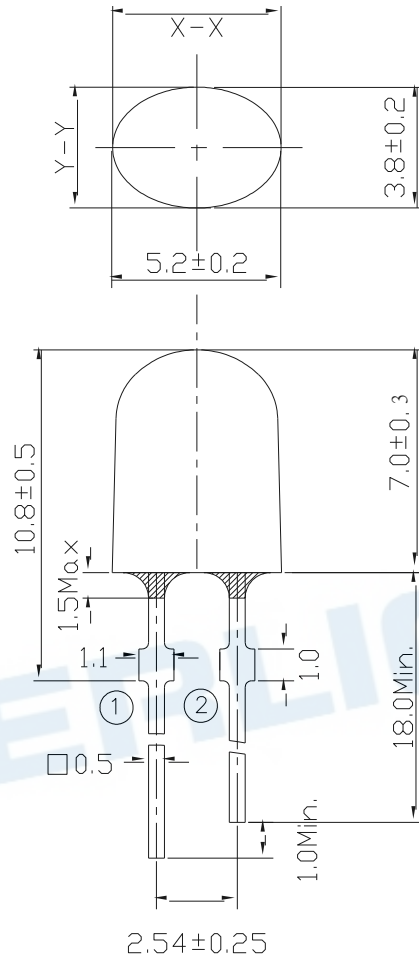

Notes:

- Other dimensions are in millimeters, tolerance is 0.25mm except being specified.
- Protruded resin under flange is 1.5mm Max LED.



LIGHTING FOREVER

Technical Data Sheet

5484BN/Y7DC-AHJB/P/MS

Absolute Maximum Rating ($T_a=25^{\circ}\text{C}$)

Parameter	Symbol	Absolute Maximum Rating	Unit
Forward Current	I_F	50	mA
Pulse Forward Current (Duty1/10@ 1KHz)	I_{FP}	160	mA
Operating Temperature	T_{opr}	-40 ~ +85	$^{\circ}\text{C}$
Storage Temperature	T_{stg}	-40 ~ +100	$^{\circ}\text{C}$
Soldering Temperature	T_{sol}	260	$^{\circ}\text{C}$
Power Dissipation	P_d	120	mW
Reverse Voltage	V_R	5	V

Notes: Soldering time ≤ 5 seconds.

Electro-Optical Characteristics ($T_a=25^{\circ}\text{C}$)

Parameter	Symbol	Min.	Typ.	Max.	Unit	Condition
Luminous Intensity	I_V	1220	--	2040	mcd	$I_F=20\text{mA}$
Viewing Angle	$2\theta_{1/2}$	--	X:110Y:40	--	deg	
Peak Wavelength	λ_p	--	591	--	nm	
Dominant Wavelength	λ_d	586	590	594		
Spectrum Half width	$\Delta\lambda$	--	15	--		
Forward Voltage	V_F	1.8	2.2	2.6	V	$V_R=5\text{V}$
Reverse Current	I_R	--	--	10	μA	

Rank Combination ($I_F=20\text{mA}$)

Rank	H2	J1	J2
Luminous Intensity	1220~1440	1440~1720	1720~2040

*Measurement Uncertainty of Luminous Intensity: $\pm 10\%$

Unit:mcd

Rank	1	2	3	4
Forward Voltage	1.8~2.0	2.0~2.2	2.2~2.4	2.4~2.6

*Measurement Uncertainty of Forward Voltage: $\pm 0.1\text{V}$

Unit:V

Rank	1a	1b	2a	2b
Dominant Wavelength	586~588	588~590	590~592	592~594

*Measurement Uncertainty of Dominant Wavelength $\pm 1.0\text{nm}$

Unit:nm



LIGHTING FOREVER

Technical Data Sheet

5484BN/Y7DC-AHJB/P/MS

Typical Electro-Optical Characteristics Curves

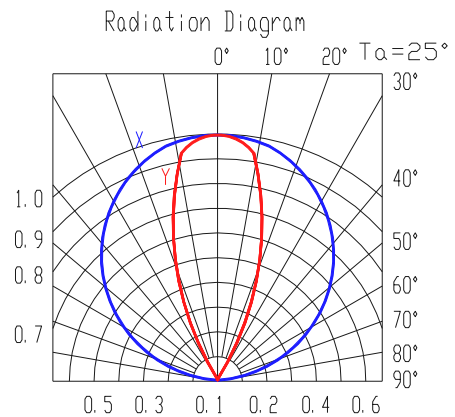
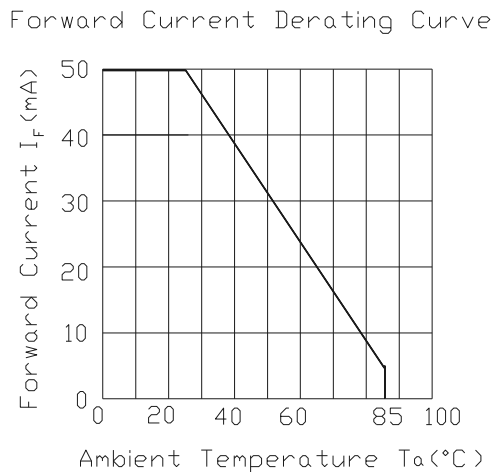
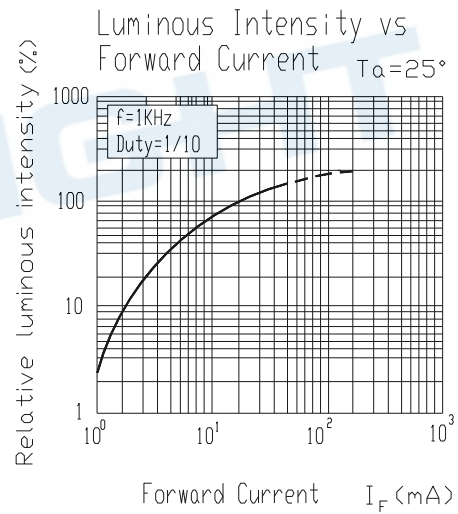
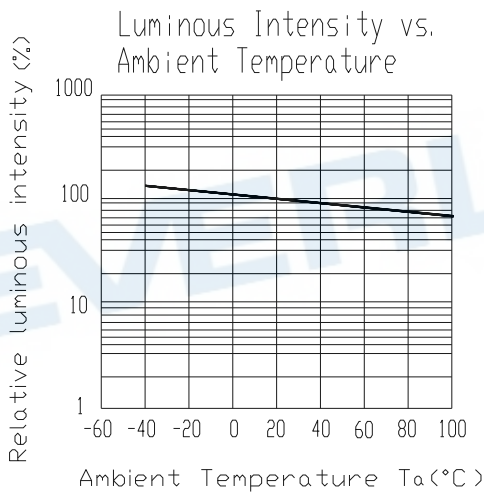
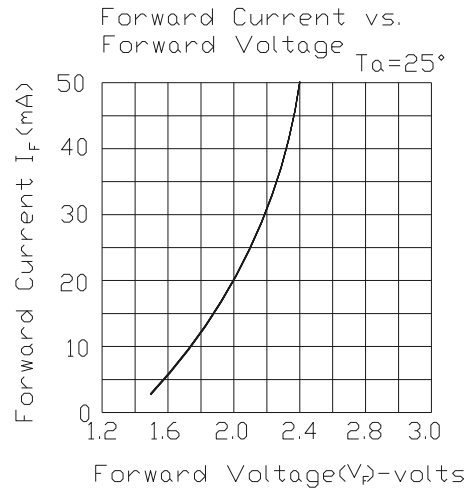
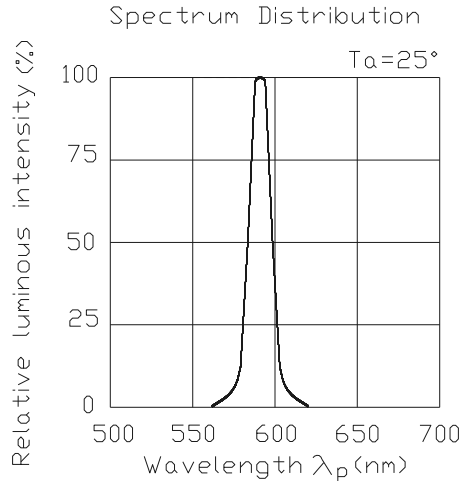



LIGHTING FOREVER

Technical Data Sheet

5484BN/Y7DC-AHJB/P/MS

Packing Specification

■ Anti-electrostatic bag

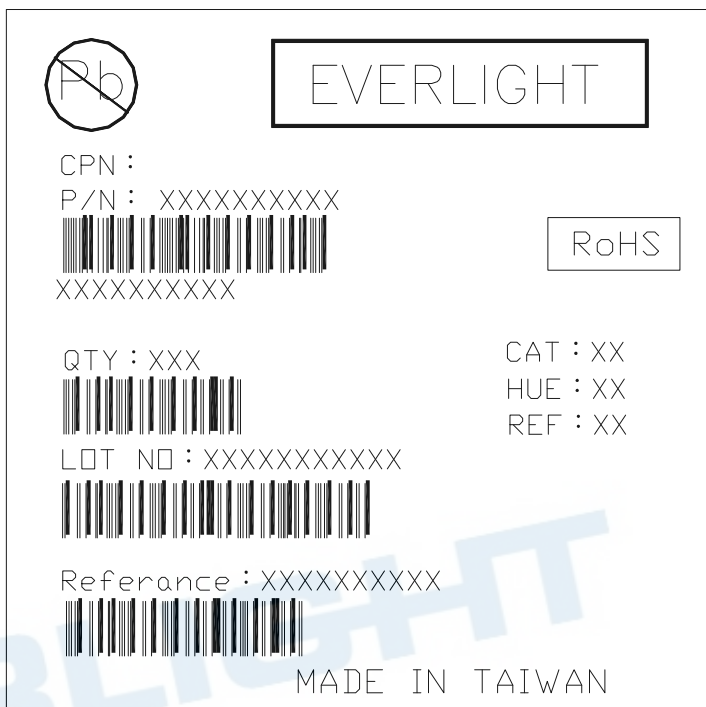
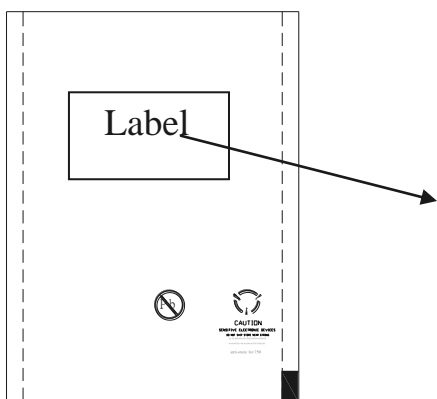

■ Inner Carton

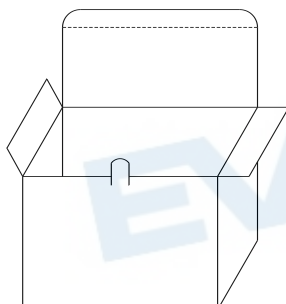

■ Label Form Specification

CPN: Customer's Production Number

P/N : Production Number

QTY: Packing Quantity

CAT: Ranks of Luminous Intensity and Forward Voltage

HUE: Rank of Dominant Wavelength

REF: Reference

LOT No: Lot Number

MADE IN TAIWAN: Production Place

Iv-Vf	Wd(Coarse Bin)	Wd(Fine Bin)-Storage spaces
CAT	HUE	REF
H2-2	1	a-X2

■ Packing Quantity

1. 500 PCS/1 Bag, 5 Bags/1 Inner Carton

2. 10 Inner Cartons/1 Outside Carton

■ Outside Carton

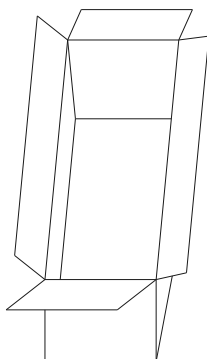

Technical Data Sheet

5484BN/Y7DC-AHJB/P/MS

Notes

1. Lead Forming

- During lead formation, the leads should be bent at a point at least 3mm from the base of the epoxy bulb.
- Lead forming should be done before soldering.
- Avoid stressing the LED package during leads forming. The stress to the base may damage the LED's characteristics or it may break the LEDs.
- Cut the LED leadframes at room temperature. Cutting the leadframes at high temperatures may cause failure of the LEDs.
- When mounting the LEDs onto a PCB, the PCB holes must be aligned exactly with the lead position of the LED. If the LEDs are mounted with stress at the leads, it causes deterioration of the epoxy resin and this will degrade the LEDs.

2. Storage

- The LEDs should be stored at 30°C or less and 70%RH or less after being shipped from Everlight and the storage life limits are 3 months. If the LEDs are stored for 3 months or more, they can be stored for a year in a sealed container with a nitrogen atmosphere and moisture absorbent material.
- Please avoid rapid transitions in ambient temperature, especially, in high humidity environments where condensation can occur.

3. Soldering

- Careful attention should be paid during soldering. When soldering, leave more than 3mm from solder joint to epoxy bulb, and soldering beyond the base of the tie bar is recommended.
- Recommended soldering conditions:

Hand Soldering		DIP Soldering	
Temp. at tip of iron	300°C Max. (30W Max.)	Preheat temp.	100°C Max. (60 sec Max.)
Soldering time	3 sec Max.	Bath temp. & time	260 Max., 5 sec Max
Distance	3mm Min.(From solder joint to epoxy bulb)	Distance	3mm Min. (From solder joint to epoxy bulb)



LIGHTING FOREVER

Technical Data Sheet

5484BN/Y7DC-AHJB/P/MS

■ Recommended soldering profile

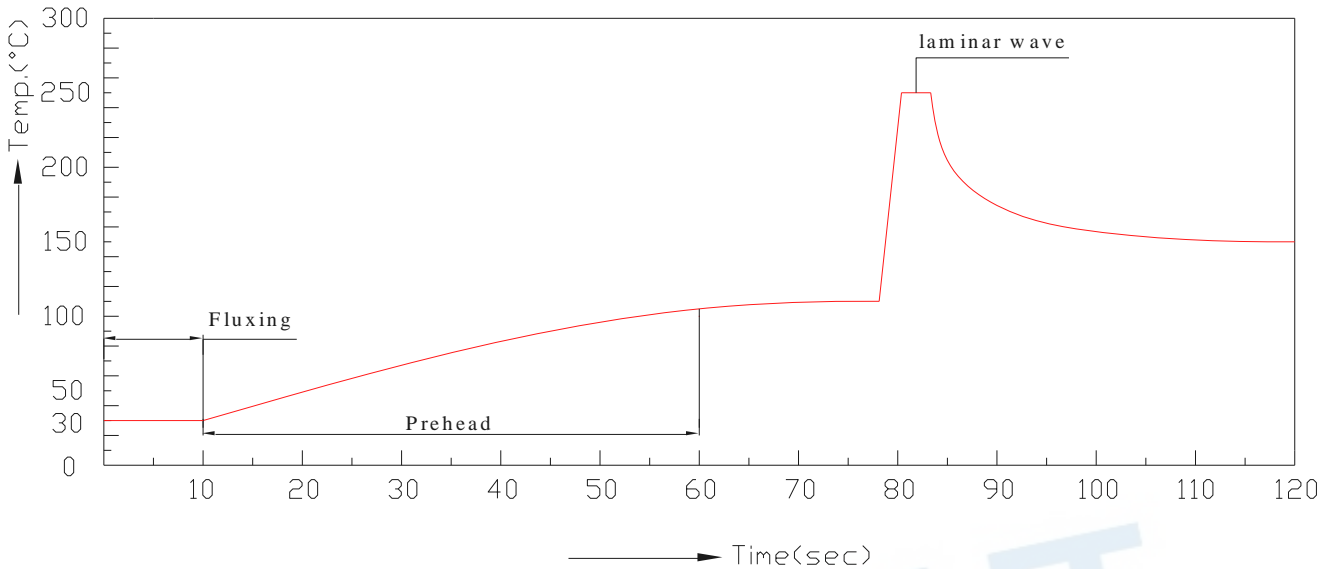

- Avoiding applying any stress to the lead frame while the LEDs are at high temperature particularly when soldering.
- Dip and hand soldering should not be done more than one time
- After soldering the LEDs, the epoxy bulb should be protected from mechanical shock or vibration until the LEDs return to room temperature.
- A rapid-rate process is not recommended for cooling the LEDs down from the peak temperature.
- Although the recommended soldering conditions are specified in the above table, dip or handsoldering at the lowest possible temperature is desirable for the LEDs.
- Wave soldering parameter must be set and maintain according to recommended temperature and dwell time in the solder wave.



LIGHTING FOREVER

Technical Data Sheet

5484BN/Y7DC-AHJB/P/MS

4. Cleaning

- When necessary, cleaning should occur only with isopropyl alcohol at room temperature for a duration of no more than one minute. Dry at room temperature before use.
- Do not clean the LEDs by the ultrasonic. When it is absolutely necessary, the influence of ultrasonic cleaning on the LEDs depends on factors such as ultrasonic power and the assembled condition. Ultrasonic cleaning shall be pre-qualified to ensure this will not cause damage to the LED.

5. Heat Management

- Heat management of LEDs must be taken into consideration during the design stage of LED application. The current should be de-rated appropriately by referring to the de-rating curve found in each product specification.
- The temperature surrounding the LED in the application should be controlled. Please refer to the data sheet de-rating curve.

6. ESD (Electrostatic Discharge)

- Electrostatic discharge (ESD) or surge current (EOS) can damage LEDs.
- An ESD wrist strap, ESD shoe strap or antistatic gloves must be worn whenever handling LEDs.
- All devices, equipment and machinery must be properly grounded.
- Use ion blower to neutralize the static charge which might have built up on surface of the LEDs plastic lens as a result of friction between LEDs during storage and handing.

7. Other

- Above specification may be changed without notice. EVERLIGHT will reserve authority on material change for above specification.
- When using this product, please observe the absolute maximum ratings and the instructions for using outlined in these specification sheets. EVERLIGHT assumes no responsibility for any damage resulting from use of the product which does not comply with the absolute maximum ratings and the instructions included in these specification sheets.



LIGHTING FOREVER

Technical Data Sheet

5484BN/Y7DC-AHJB/P/MS

- These specification sheets include materials protected under copyright of EVERLIGHT corporation. Please don't reproduce or cause anyone to reproduce them without EVERLIGHT's consent.

EVERLIGHT

EVERLIGHT ELECTRONICS CO., LTD.
Office: No 25, Lane 76, Sec 3, Chung Yang Rd,
Tucheng, Taipei 236, Taiwan, R.O.C

Tel: 886-2-2267-2000, 2267-9936
Fax: 886-2267-6244, 2267-6189, 2267-6306
<http://www.everlight.com>