

### EL 3030E XI3030-C03501H-AM

**Preliminary**

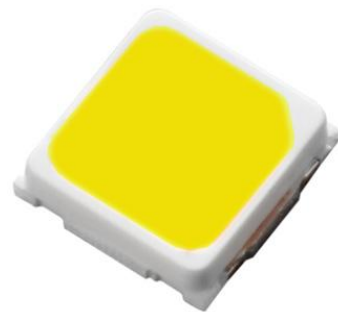

### Features

- Package : Cool White LEDs on EMC substrate
- Typ. Color Temperature : 5180 K ~ 6680 K
- Typ. Luminous Flux : 120 lm @ 350mA
- Viewing angle : 115 °
- ESD : up to 8KV
- MSL : 2a
- Preconditioning : According to JEDEC J-STD 020D Level 2a
- Qualifications : According to AEC-Q101
- Compliance with RoHS

### Applications

- Automotive Exterior Lighting , Day Time Running Light (DRL), Tail Light

# Contents

1. Characteristics.....	3
2. Absolute Maximum Ratings.....	4
3. Characteristics Graph.....	5
4. Binning Information.....	10
5. Part Number .....	15
6. Ordering Information.....	16
7. Mechanical Dimension .....	17
8. Recommended Soldering Pad .....	18
9. Reflow Soldering Profile.....	18
10. Packaging Information .....	19
11. Handling of Silicon Resin for LEDs .....	21
12. Precaution for Use .....	22

# 1. Characteristics

Parameter	Symbol	Min.	Typ.	Max.	Unit	Condition	
Forward Current	$I_F$	50	350	500	mA	---	
Luminous Flux <sup>[1][2][3]</sup>	$\Phi_v$	100	120	150	lm	$I_F=350\text{mA}$	
Forward Voltage <sup>[4][5]</sup>	$V_F$	2.5	3.1	3.5	V	$I_F=350\text{mA}$	
Viewing Angle	$\varphi$	---	115	---	deg	$I_F=350\text{mA}$	
Color Temperature	CCT	5180	5850	6680	K	$I_F=350\text{mA}$	
Thermal Resistance (Junction to Solder)	Real	$R_{th\ JS\ real}$	---	21.42	---	K/W	$I_F=350\text{mA}$
	Electrical	$R_{th\ JS\ el}$	---	10.62	---		

**Notes:**

1. Luminous Flux measurement tolerance:  $\pm 8\%$ .
2. The data of Luminous Flux measured at thermal pad=25°C.
3. Typical luminous flux or light output performance is operated within the condition guided by this datasheet.
4. Forward voltage measurement tolerance:  $\pm 0.05\text{V}$ .
5. The  $V_F$  range shown in the table above indicates 99% output.
6. Tolerance of Chromaticity Coordinates  $x,y$  :  $\pm 0.005$ .

## 2. Absolute Maximum Ratings

Parameter	Symbol	Ratings	Unit
Reverse Voltage	$V_R$	Not designed for reverse operation	V
Power Dissipation	$P_d$	2870	mW
Max. DC Forward Current	$I_F$	700	mA
Surge current	$I_{FM}$	2500	mA
Junction Temperature	$T_J$	140	°C
Operating Temperature	$T_{opr}$	-40 ~ +125	°C
Storage Temperature	$T_{stg}$	-40 ~ +125	°C
ESD Sensitivity (R=1.5kΩ, C= 100pF)	$ESD_{HBM}$	8	kV
Soldering Temperature	Reflow	260°C for 30 sec	°C

### 3.Characteristics Graph

**Wavelength Characteristics Relative Spectral Distribution**  
@ Ts = 25°C, If=350mA

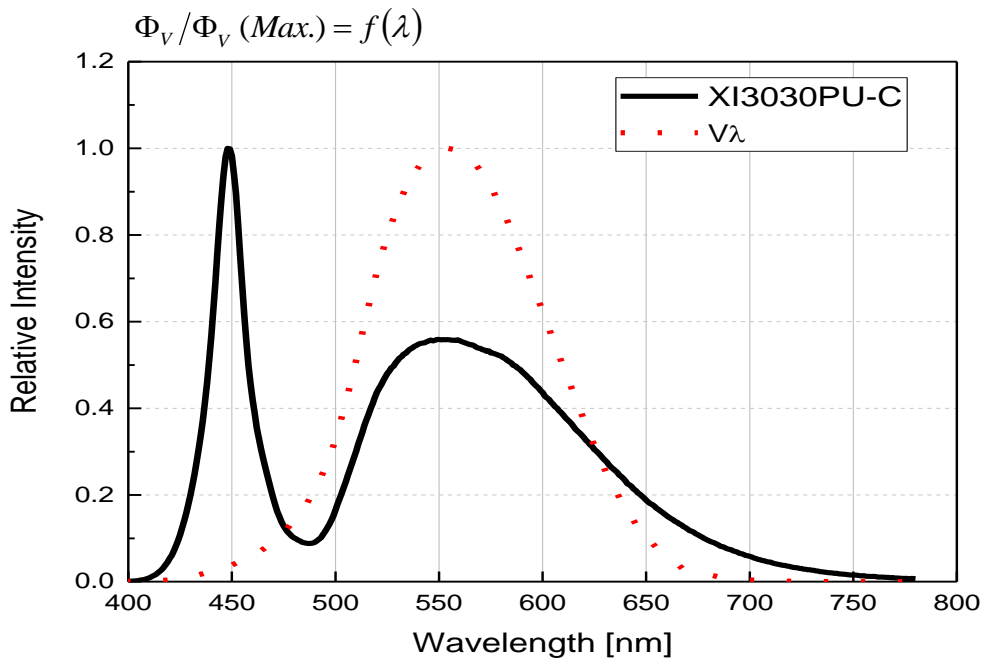

**Typical Diagram Characteristics of Radiation**

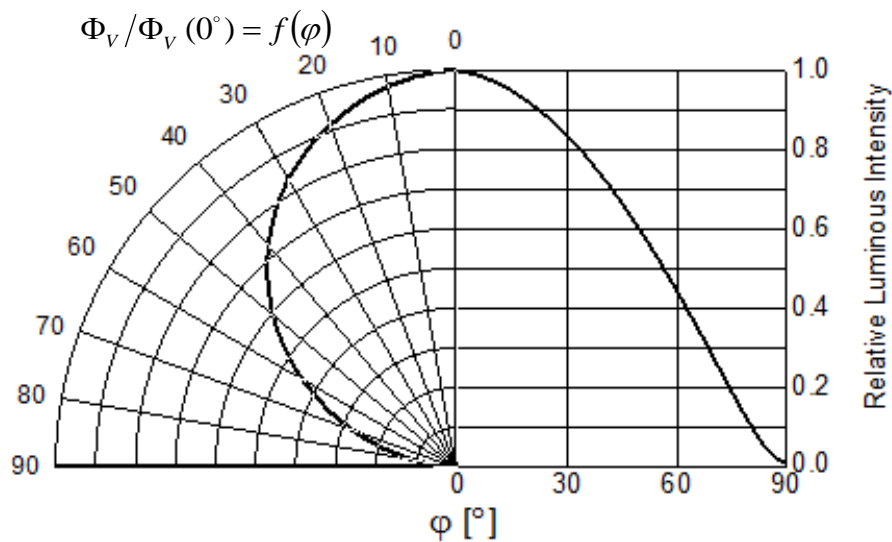

**Notes:**

1.  $\varphi$  is the off axis angle from lamp centerline where the luminous intensity is 1/2 of the peak value.
2. View angle tolerance is  $\pm 5$

**Forward Current vs. Forward Voltage**  
@ Ts = 25°C

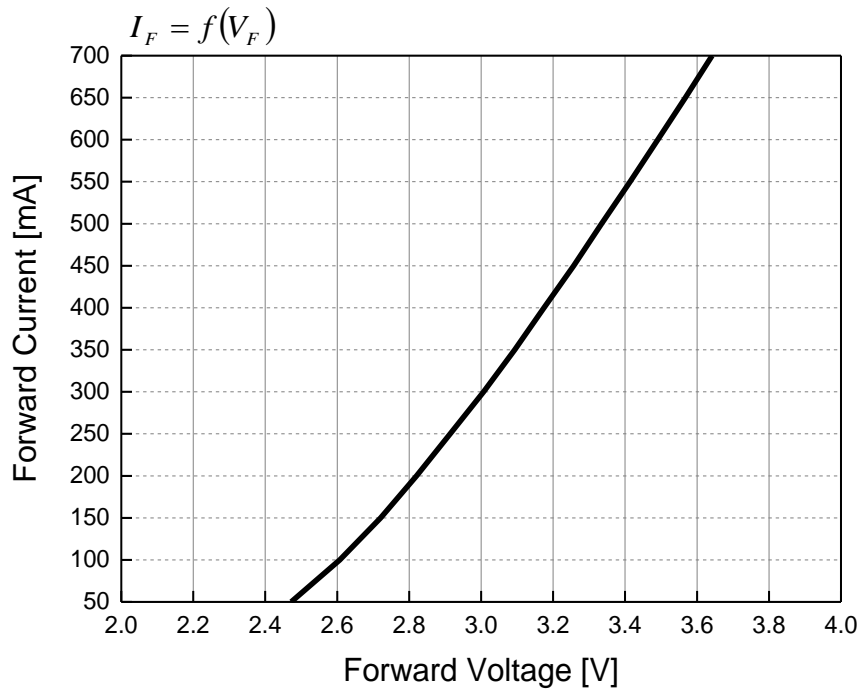

**Relative Luminous Flux vs. Forward Current**  
@ Ts = 25°C

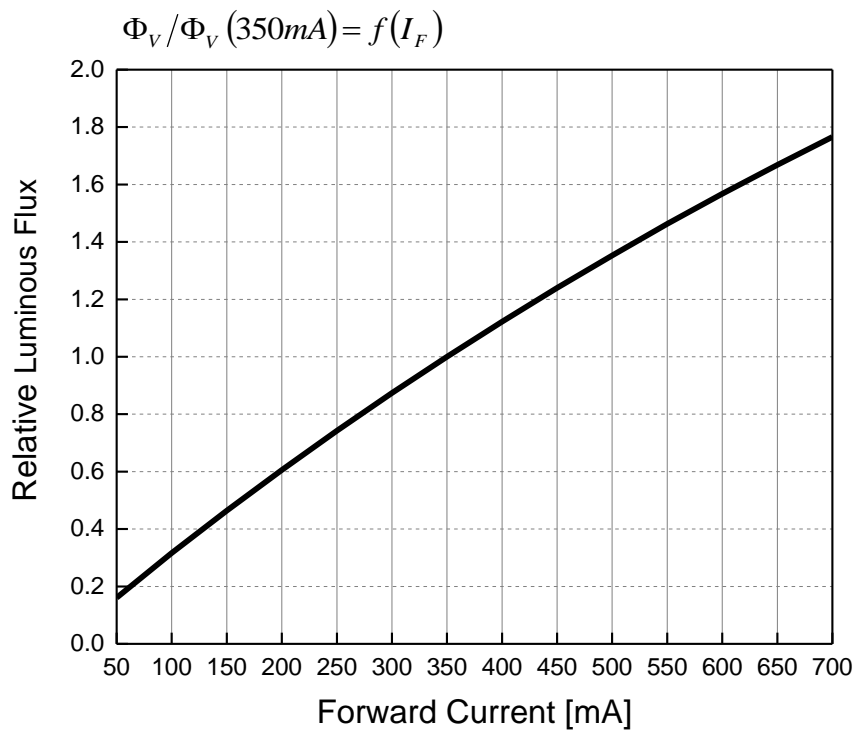

**Chromaticity Coordinates Shift vs. Forward Current**  
@  $T_s = 25^\circ\text{C}$

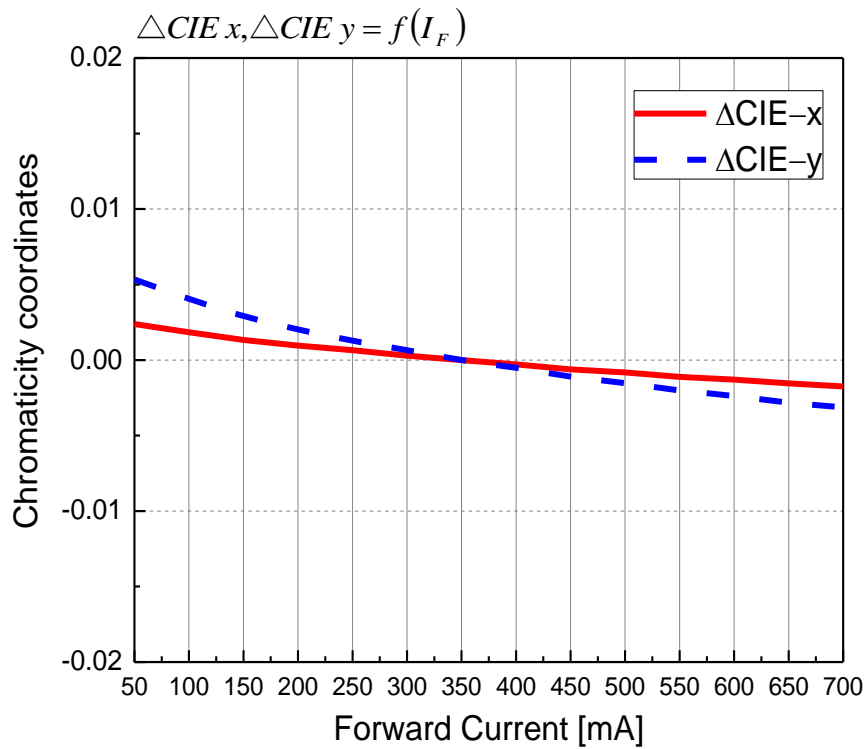

**Relative Forward Voltage vs. Junction Temperature**  
@  $I_F=350\text{mA}$

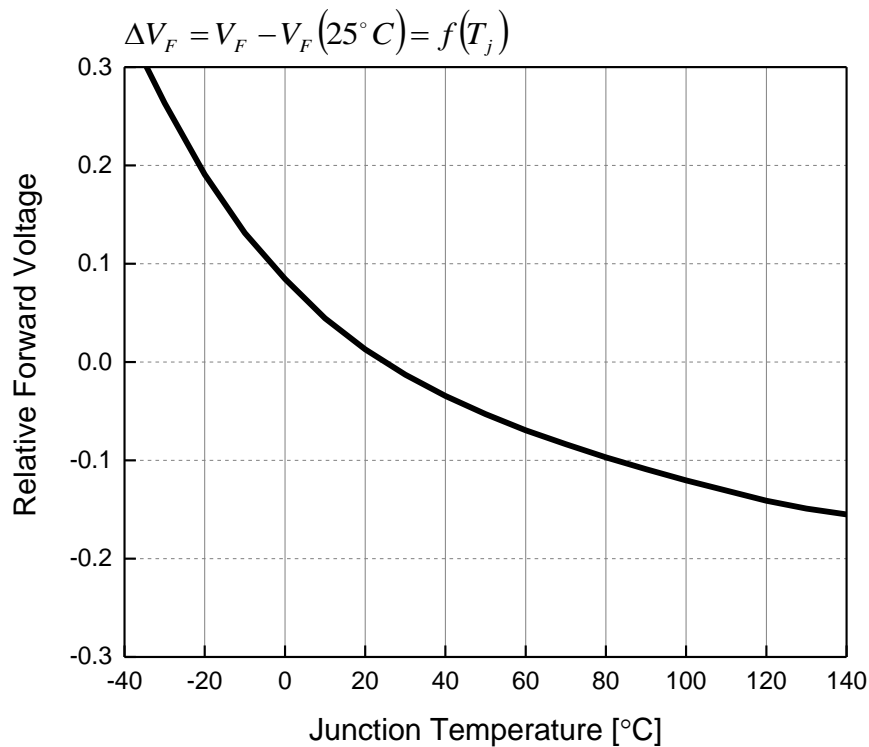

### Relative Luminous Flux vs. Junction Temperature @ $I_F=350\text{mA}$

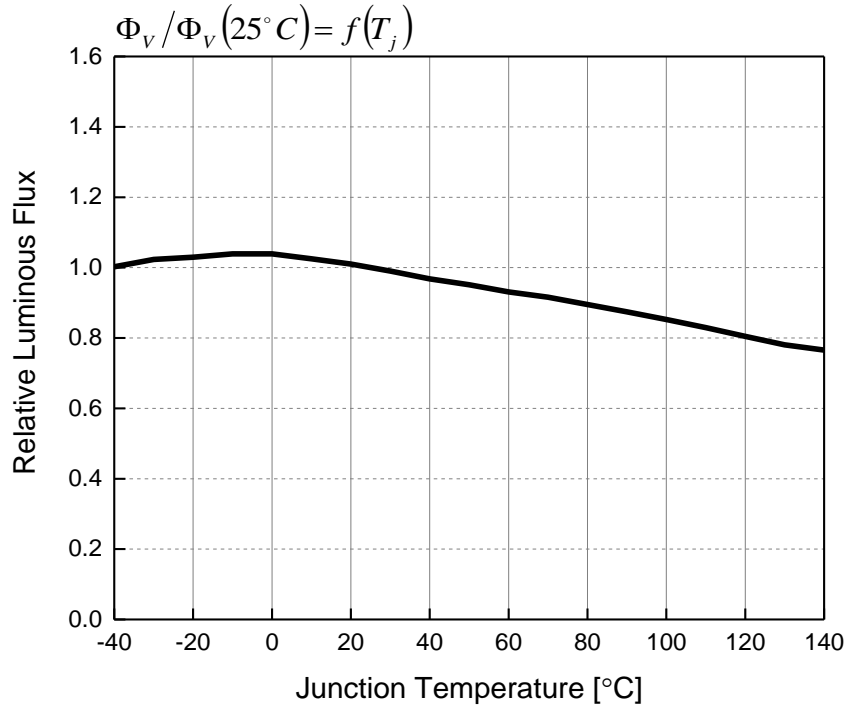

### Chromaticity Coordinates Shift vs. Junction Temperature @ $I_F=350\text{mA}$

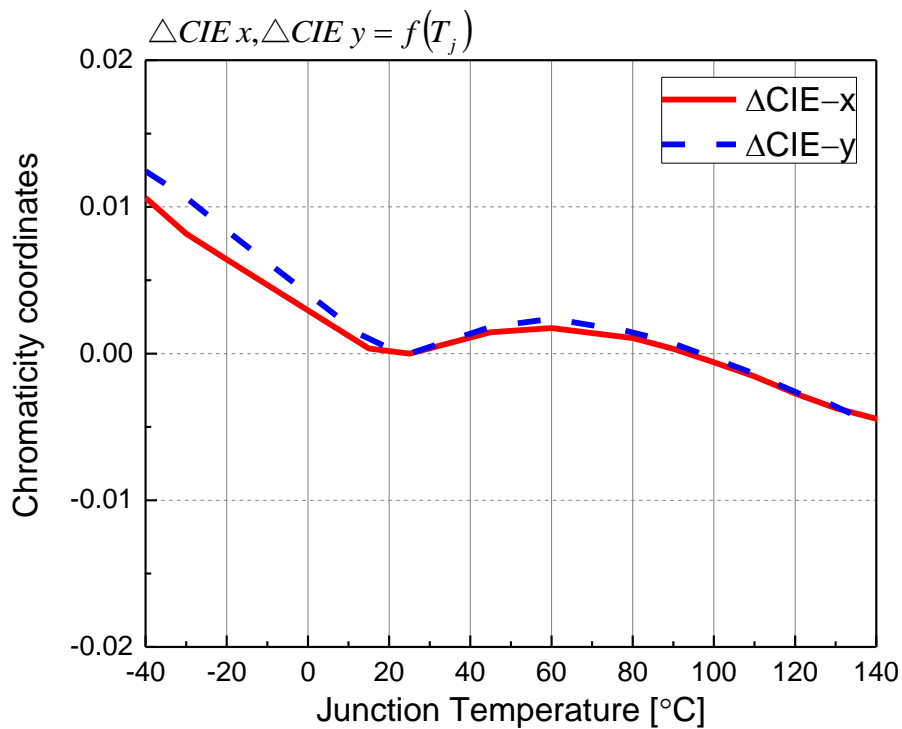



### Forward Current Derating Curve

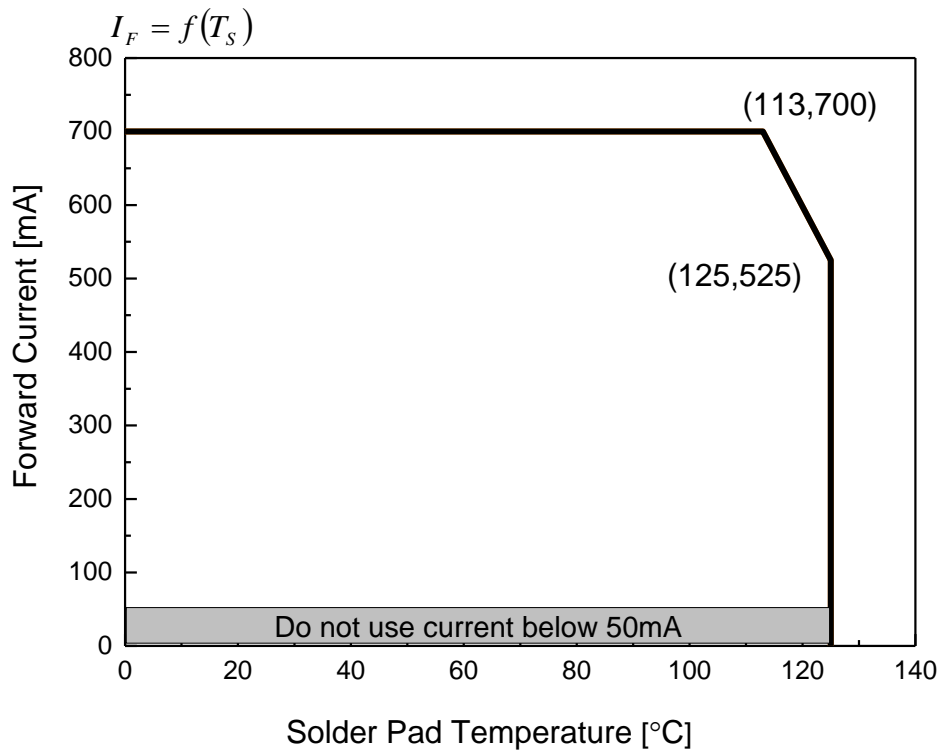

### Permissible Pulse Handling Capability

D=Duty cycle ,  $T_s = 25C$

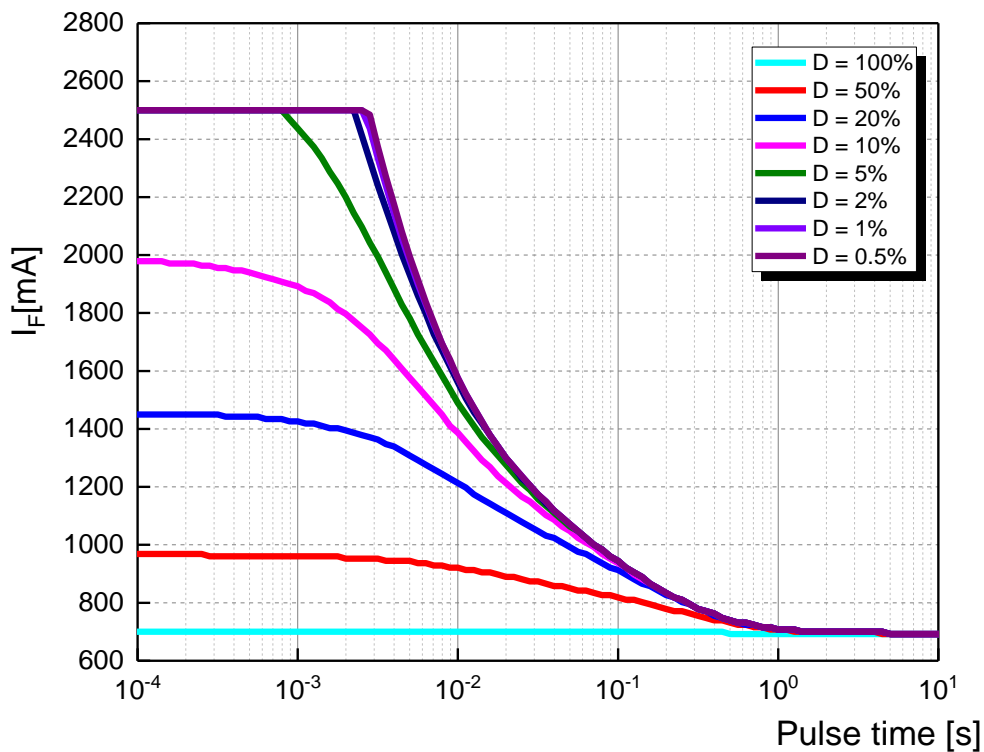

## 4. Binning Information

### Luminous Flux Bins

Group	Bin	Minimum Photometric Flux (lm)	Maximum Photometric Flux (lm)
E	1	4	5
	2	5	6
	3	6	8
	4	8	10
	5	10	13
	6	13	17
	7	17	20
	8	20	23
	9	23	27
F	1	27	33
	2	33	39
	3	39	45
	4	45	52
	5	52	60
	6	60	70
	7	70	80
	8	80	90
	9	90	100

Group	Bin	Minimum Photometric Flux (lm)	Maximum Photometric Flux (lm)
J	1	100	110
	2	110	120
	3	120	130
	4	130	140
	5	140	150
	6	150	160
	7	160	180
	8	180	200
	9	200	225
K	1	225	250
	2	250	275
	3	275	300
	4	300	325
	5	325	350
	6	350	375
	7	375	400
	8	400	425
	9	425	450

**Notes:**

1. Luminous flux measurement tolerance:  $\pm 8\%$ .
2. Highlighted Black Box is available bins.

## Product Binning ECE White Bin Structure

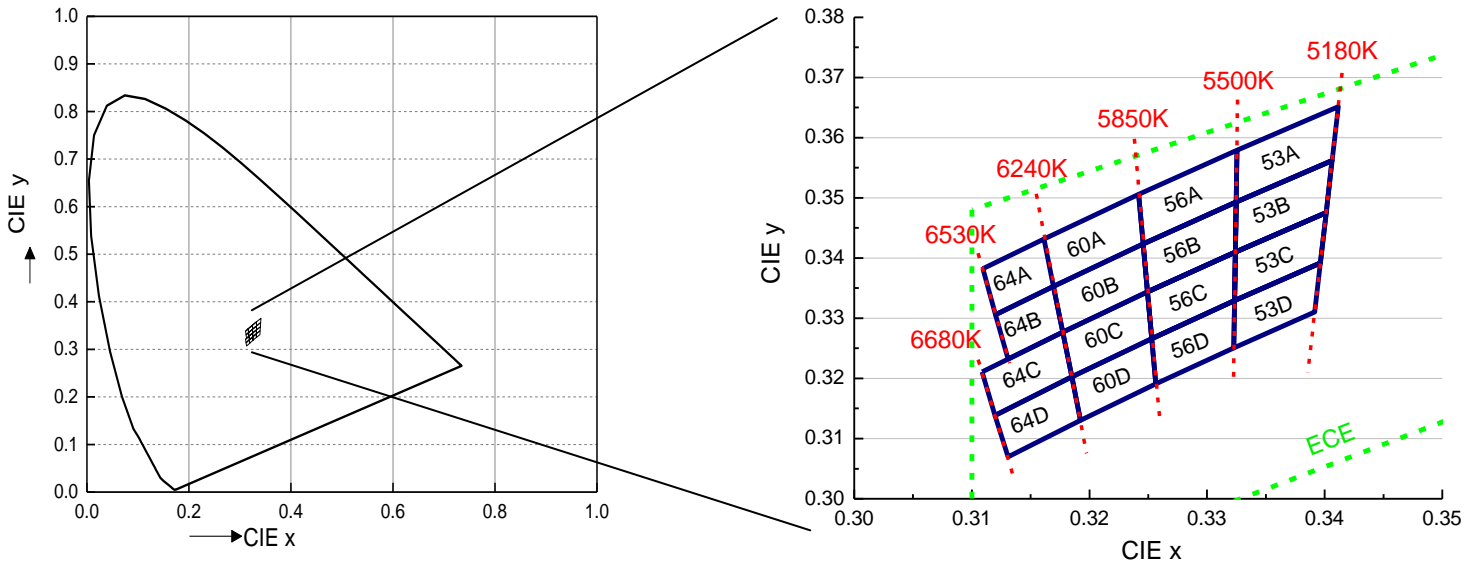

### Cool White Bin Coordinates

Bin	CIE x	CIE y
64A	0.3109	0.3382
	0.3161	0.3432
	0.3169	0.3353
	0.3120	0.3306
Reference Range: 6240~6530K		

Bin	CIE x	CIE y
64B	0.3120	0.3306
	0.3169	0.3353
	0.3177	0.3277
	0.3131	0.3232
Reference Range: 6240~6530K		

Bin	CIE x	CIE y
64C	0.3109	0.3211
	0.3177	0.3277
	0.3185	0.3203
	0.3120	0.3139
Reference Range: 6240~6680K		

Bin	CIE x	CIE y
64D	0.3120	0.3139
	0.3185	0.3203
	0.3192	0.3131
	0.3131	0.3070
Reference Range: 6240~6680K		

Bin	CIE x	CIE y
60A	0.3161	0.3432
	0.3242	0.3506
	0.3246	0.3424
	0.3169	0.3353
Reference Range: 5850~6240K		

Bin	CIE x	CIE y
60B	0.3169	0.3353
	0.3246	0.3424
	0.3249	0.3344
	0.3177	0.3277
Reference Range: 5850~6240K		

### Cool White Bin Coordinates

Bin	CIE x	CIE y
60C	0.3177	0.3277
	0.3249	0.3344
	0.3253	0.3266
	0.3185	0.3203
Reference Range: 5850~6240K		

Bin	CIE x	CIE y
60D	0.3185	0.3203
	0.3253	0.3266
	0.3256	0.3191
	0.3192	0.3131
Reference Range: 5850~6240K		

Bin	CIE x	CIE y
56A	0.3242	0.3506
	0.3325	0.3579
	0.3325	0.3493
	0.3246	0.3424
Reference Range: 5500~5850K		

Bin	CIE x	CIE y
56B	0.3246	0.3424
	0.3325	0.3493
	0.3324	0.3410
	0.3249	0.3344
Reference Range: 5500~5850K		

Bin	CIE x	CIE y
56C	0.3249	0.3344
	0.3324	0.3410
	0.3323	0.3329
	0.3253	0.3266
Reference Range: 5500~5850K		

Bin	CIE x	CIE y
56D	0.3253	0.3266
	0.3323	0.3329
	0.3323	0.3251
	0.3256	0.3191
Reference Range: 5500~5850K		

Bin	CIE x	CIE y
53A	0.3325	0.3579
	0.3412	0.3652
	0.3406	0.3562
	0.3325	0.3493
Reference Range: 5180~5500K		

Bin	CIE x	CIE y
53B	0.3325	0.3493
	0.3406	0.3562
	0.3401	0.3476
	0.3324	0.3410
Reference Range: 5180~5500K		

Bin	CIE x	CIE y
53C	0.3324	0.3410
	0.3401	0.3476
	0.3396	0.3392
	0.3323	0.3329
Reference Range: 5180~5500K		

Bin	CIE x	CIE y
53D	0.3323	0.3329
	0.3396	0.3392
	0.3392	0.3310
	0.3323	0.3251
Reference Range: 5180~5500K		

**Notes:** 1. Color coordinates measurement allowance:  $\pm 0.005$

### Forward Voltage Bins

Bin code	Forward Voltage [V]
10	1.00
12	1.25
15	1.50
17	1.75
20	2.00
22	2.25
25	2.50
27	2.75
30	3.00
32	3.25
35	3.50
37	3.75
40	4.00
42	4.25
45	4.50
47	4.75
50	5.00
52	5.25
55	5.50
57	5.75
60	6.00
62	6.25
65	6.50
67	6.75
70	7.00

**Notes:**

1. Bin code defines either Minimum or Maximum Value of the Bin.
2. Forward voltage bins are defined at  $I_F = 350\text{mA}$  operation.
3. Highlighted Black Box is available bins.

## 5.Part Number

### XI3030-C03501H-AM

Part number is designated with below details.

XI3030 = Product family name.

C = Color [1]

0 = CRI ( 0=N/A ; >70%=7 ; >80%=8 ; >90%=9 )

350 = Test current [mA]

1 = Lead Frame Type ( 0=Ag ; 1=Au)

H = Brightness Level ( H=High ; L=Low)

AM = Automotive Application

Note

[1] Color :

Symbol	Description
C	Cool White
N	Neutral White
W	Warm White
PA	Phosphor Converted Amber
PR	Phosphor Converted Red
UB	Blue
IB	Ice Blue
SB	Sky Blue
UG	Green
UY	Yellow
UA	Amber
UR	Red
SR	Super Red
RGB	RGB – Color
RGBY	RGBY – Color

## 6. Ordering Information

### XI3030-C03501H-**ABCDEFGHIJKLMNO-PQ**-AM

Part Number of the EL 3030E	Order Code
XI3030-C03501H-AM	XI3030-C03501H-53A64DJ1J42535-2T-AM

Order code contains information with below details :

ABCDEF = min/max wavelength or CCT

GHJK = min./max. luminous flux in [lm] or luminous intensity in [mcd]

LMNO = min./max. forward voltage

PQ = internal code

## 7. Mechanical Dimension

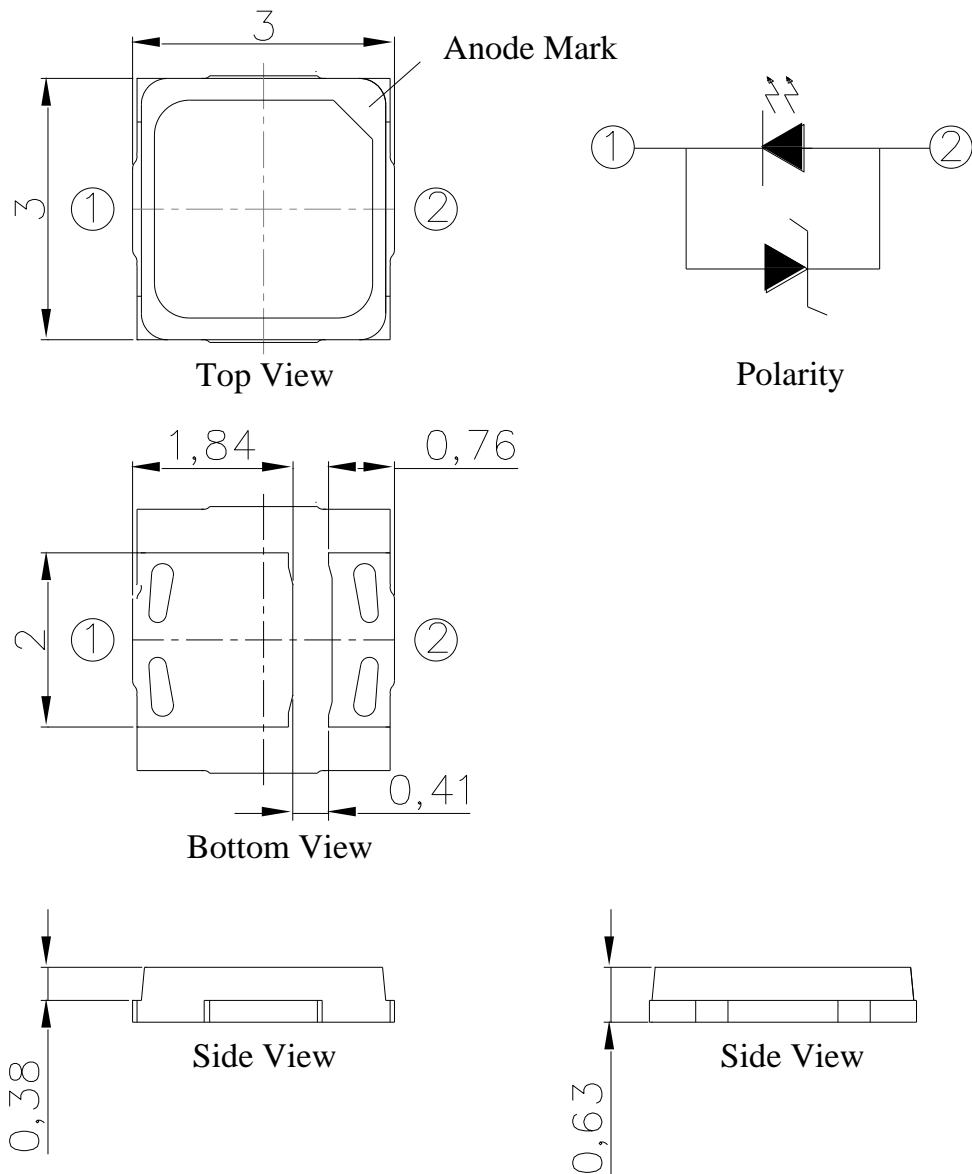

### Notes:

1. Dimensions are in millimeters.
2. Tolerances unless mentioned are  $\pm 0.1\text{mm}$ .



## 8.Recommended Soldering Pad

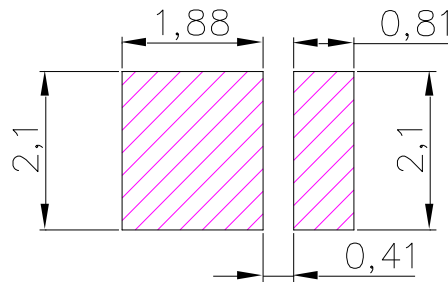

## 9.Reflow Soldering Profile

Soldering Condition (Reference: IPC/JEDEC J-STD-020D)

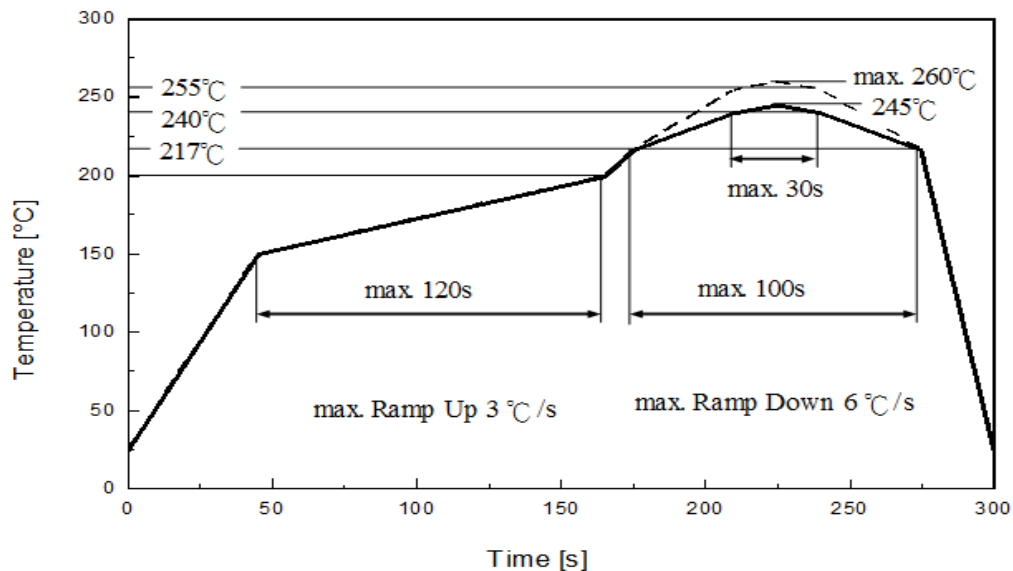

Profile Feature	Pb-Free Assembly	Unit Einheit
	Recommendation	
Ramp-up rate to preheat 25 °C to 150 °C	3	°C /sec
Time of soaking zone 150 °C to 200 °C	120	sec
Ramp-up rate to peak	3	°C /sec
Liquidus temperature	217	°C
Time above liquidus temperature	100	sec
Peak temperature (max.)	260	°C
Time within 5°C of the specified peak temperature	30	sec
Ramp-down Rate (max.)	6	°C /sec

## 10. Packaging Information

### • Product Labeling



- CPN : Customer's Product Number
- P/N : Everlight Part Number
- QTY : Packing Quantity
- CAT : Luminous Flux (Brightness) Bin
- HUE : Color Bin
- REF : Forward Voltage Bin
- LOT No : Lot Number

### • Packing: Loaded Quantity 2000 pcs Per Reel

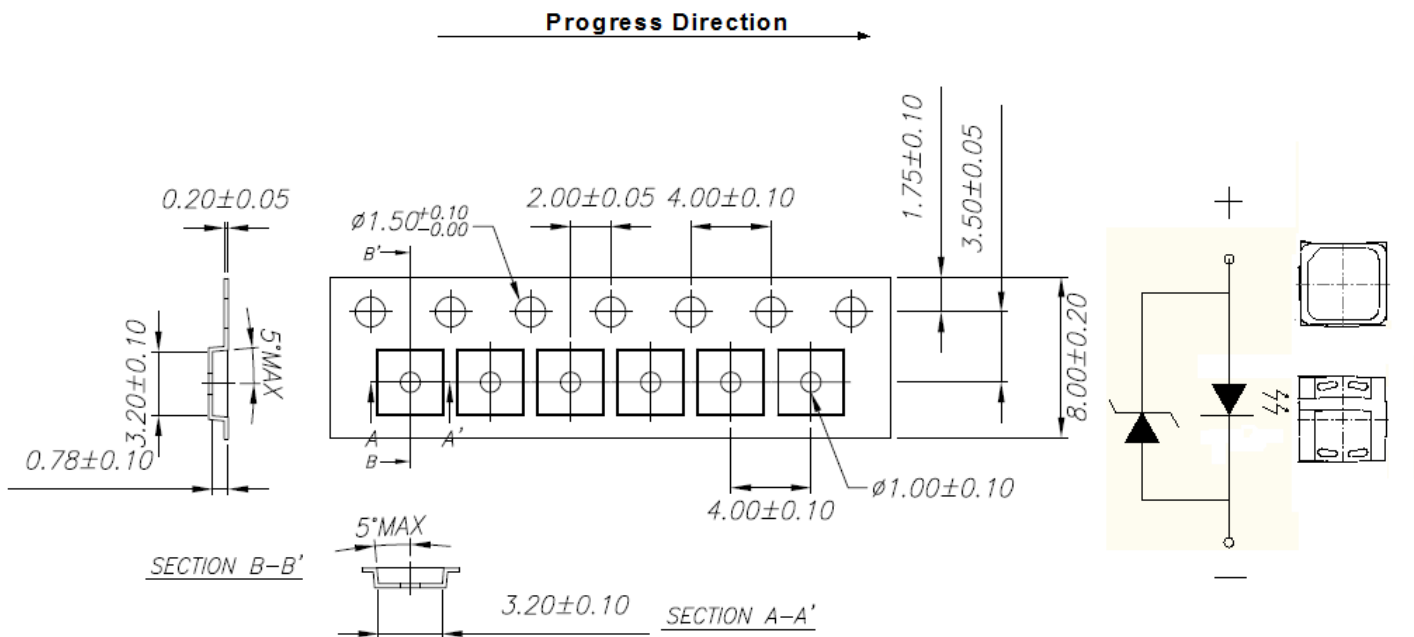

#### Notes:

1. Dimensions are in millimeters.
2. Tolerances for fixed dimensions are  $\pm 0.2\text{mm}$ .

## ● Reel Dimensions

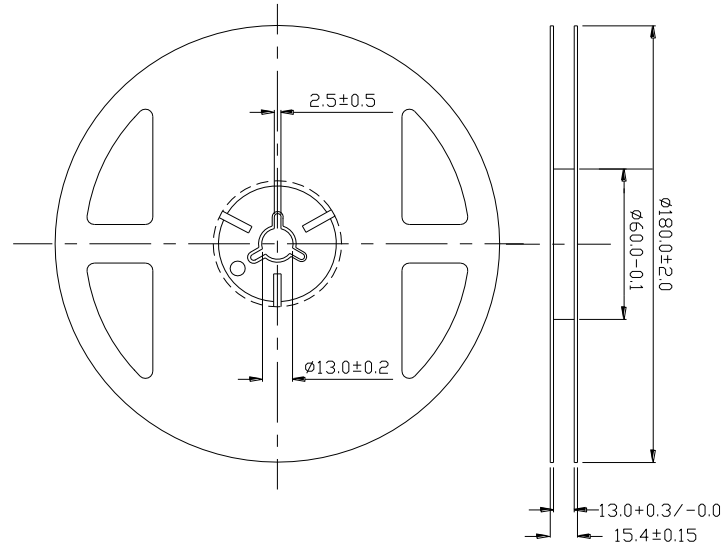

### Notes:

1. Dimensions are in millimeters.
2. Tolerances unless mentioned are  $\pm 0.2$ mm.

## ● Moisture Resistant Packing Process

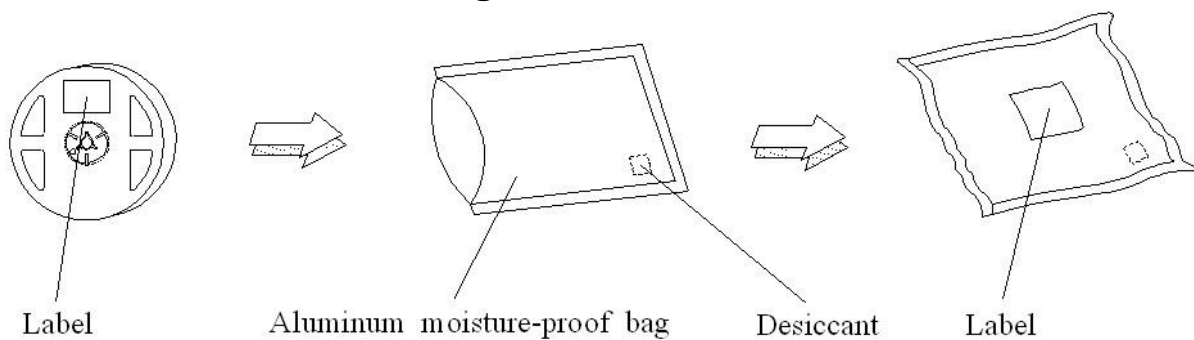

### Notes:

1. Dimensions are in millimeters.
2. Tolerances unless mentioned are  $\pm 0.2$ mm.

## 11. Handling of Silicon Resin for LEDs

- Do not put mechanical stress on the LED.
- When handling the product, do not apply direct pressure on the optical surface. The LED surface could be damaged, which could affect the optical performance of the LED.
- In low-humidity work environment, please keep handling the LEDs with appropriate ESD grounding.
- It is recommended to handle the LED with powder-less latex gloves.
- Do not touch the resin with tweezers to avoid scratching or other damage.

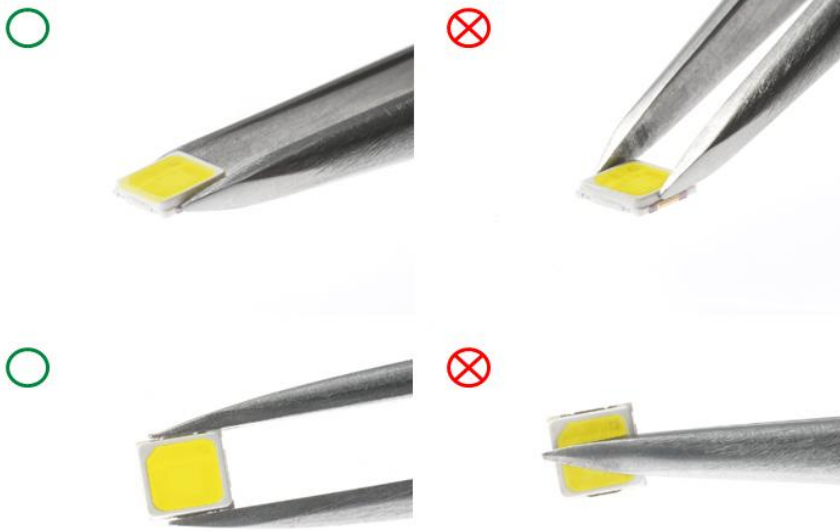

## 12. Precaution for Use

- Before the package is opened, the LEDs should be stored at 30°C or less and 90%RH or less after being shipped from Everlight and the storage life limits are 18 months. The LEDs can be stored up to 3 years in a sealed container with a nitrogen atmosphere and moisture absorbent material.
- After opening the package, all unused LEDs are recommended to be stored in moisture proof packages.
- If the moisture absorbent material (silica gel) has exceeded effectiveness or the LEDs have exceeded the storage time, baking treatment should be performed using the following conditions. Baking treatment: 60±5°C for 24 hours.

## Revision History

Current version: Jun.08.2017

Issue No: Preliminary

Version: 0.4

Created by: Sam Lu

Rev.	Subjects (major change in previous version)	Modified date
0.4	Preliminary	2017/06/08