

**CHIP COIL (CHIP INDUCTORS) DFE18SBN□□□ME0L REFERENCE SPECIFICATION**

**1. Scope**

This reference specification applies to DFE18SBN\_E0 series, Chip coil (Chip Inductors).

**2.Part Numbering**

(ex)	DF	E	18	SB	N	1R0	M	E	0	L
	Product ID	Structure	Dimension (L×W)	Applications and Characteristics	Category	Inductance	Tolerance	Dimension (T)	Other	Packaging

**3.Rating**

- Operating Temperature Range  
(Ambient temperature; Self-temperature rise is not included) -40 to +85°C  
(Product temperature; Self-temperature rise is included) -40 to +125°C
- Storage Temperature Range. -40 to +85°C
- Absolute maximum voltage 20V DC

Customer Part Number	Murata Part Number	Inductance		DC Resistance (Ω)(Max.)	*3 Rated Current(mA)	
		(μH)	Tolerance (%)		*1 Based on inductance change	*2 Based on Temperature rise
	DFE18SBN1R0ME0L	1.0	±20	0.120	1900	1800

- \*1: The saturation allowable DC current value is specified when the decrease of the initial Inductance value at 30%.
- \*2: When applied Rated current to the Products, temperature rise caused by self-generated heat shall be limited to 40°C max.
- \*3: Keep the temperature (ambient temperature plus self-generation of heat) under 125°C.

**4. Testing Conditions (Standard atmospheric conditions)**

- |   |  |
|---|--|
| <p>&lt;Unless otherwise specified&gt;</p> <p>Temperature : Ordinary Temperature (15 to 35°C)</p> <p>Humidity : Ordinary Humidity (25 to 85 %(RH))</p> | <p>&lt;In case of doubt&gt;</p> <p>Temperature : 20 ± 2°C</p> <p>Humidity : 60 to 70 %(RH)</p> <p>Atmospheric Pressure : 86 to 106 kPa</p> |
|---|--|

**5.Appearance and Dimensions**

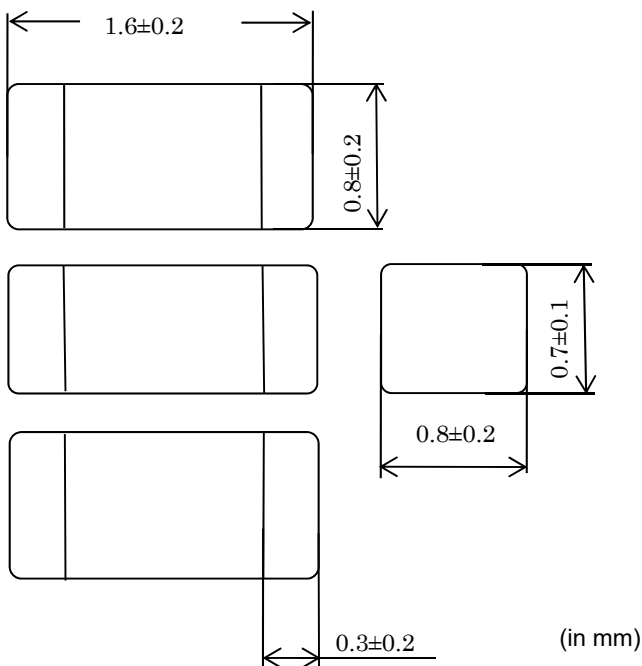

## 6. Electrical Performance

No.	No.	Item	Specification
6.1	Inductance	Inductance shall meet item 3.	Measuring Equipment: Agilent 4284A or equivalent (0.5V)
6.2	DC Resistance		Measuring Frequency: 1MHz Measuring Equipment: Digital multi meter
6.3	Rated Current	Self temperature rise shall be limited to 40°C max.	The rated current is applied.

## 7. Mechanical Performance

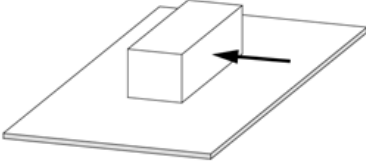
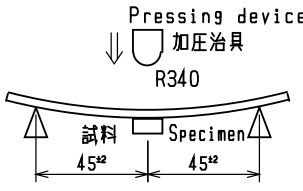
No.	Item	Specification	Test Method
7.1	Shear Test	Chip coil shall not be damaged.	It shall be soldered on the substrate. Applying Force(F) : 10N Hold Duration: 5s 
7.2	Bending Test	Chip coil shall not be damaged.	Substrate: Glass-epoxy substrate (100×40×1.0mm) Speed of Applying Force: 0.5mm / s Deflection: 2mm Hold Duration: 20s  (in mm)
7.3	Vibration	Chip coil shall not be damaged.	It shall be soldered on the substrate. Oscillation Frequency : 10 to 55 to 10Hz for 1 minutes Total amplitude : 1.5 mm or Acceleration amplitude 98m/s <sup>2</sup> whichever is smaller. Testing Time: A period of 2 hours in each of 3 mutually perpendicular directions. (Total 6 hours)
7.4	Solderability	The wetting area of the electrode shall be at least 90% covered with new solder coating.	Flux: Ethanol solution of rosin, 25(wt)% (Immersed for 5s to 10s) Solder : Sn-3.0Ag-0.5Cu Pre-Heating: 150±10°C / 60 to 90s Solder Temperature: 245±5°C Immersion Time: 3 s
7.5	Resistance to Soldering Heat	Appearance: No damage Inductance Change : within ±10%	Reflow soldering method Flux: Ethanol solution of rosin, 25(wt)% Solder: Sn-3.0Ag-0.5Cu Pre-Heating: 150~180°C / 90±30s Solder Temperature: 230°C min / 30±10s Peak Temperature: 250+5/-0°C Reflow times: 2 times max Test board shall be 0.8 mm thick. Base material shall be glass epoxy resin. Then measured after exposure Standard atmospheric conditions for 1~2 hours.

**8.Environmental Performance (It shall be soldered on the substrate.)**

No.	Item	Specification	Test Method
8.1	Heat Resistance	Appearance:No damage Inductance Change : within ±10%	Temperature: 125±2°C Time: 500h (± 12h) Then measured after exposure Standard atmospheric conditions for 1~2 hours.
8.2	Cold Resistance		Temperature: -40±2°C Time: 500h (± 12h) Then measured after exposure Standard atmospheric conditions for 1~2 hours.
8.3	Humidity		Temperature: 40±2°C Humidity: 90~95%(RH) Time: 500h (± 12h) Then measured after exposure Standard atmospheric conditions for 1~2 hours.
8.4	Temperature Cycle		1 cycle: 1 step: -40±2°C / 30±3 min 2 step: Ordinary temp. / 3min max. 3 step: +125±2°C / 30±3 min 4 step: Ordinary temp. / 3min max. Total of 100 cycles Then measured after exposure Standard atmospheric conditions for 1~2 hours.

**9. Specification of Packaging**

9.1 Appearance and Dimensions of plastic tape

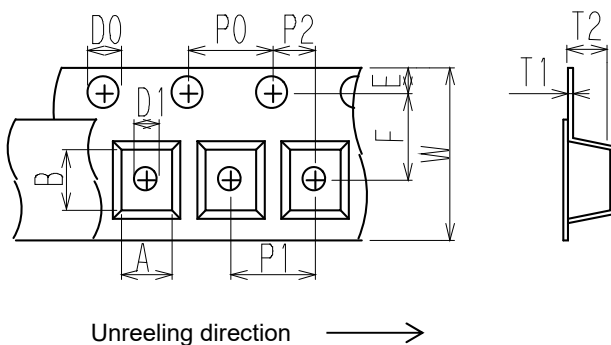

A	1.15 $\begin{smallmatrix} +0.1 \\ -0.05 \end{smallmatrix}$	P0	4.0 ±0.1
B	1.95 ±0.05	P1	4.0 ±0.1
D0	$\phi$ 1.5 $\begin{smallmatrix} +0.1 \\ -0 \end{smallmatrix}$	P2	2.0 ±0.05
D1	$\phi$ 0.8 $\begin{smallmatrix} +0.1 \\ -0 \end{smallmatrix}$	T1	0.25 ±0.05
E	1.75 ±0.1	T2	0.92 ±0.05
F	3.5 ±0.05	W	8.0 ±0.2

(in mm)

9.2 Specification of Taping

- (1) Packing quantity (standard quantity)  
3,000 pcs / reel
- (2) Packing Method  
Products shall be packed in the each embossed cavity of plastic tape and sealed by cover tape.
- (3) Sprocket hole  
The sprocket holes are to the right as the tape is pulled toward the user.
- (4) Spliced point  
Plastic tape and Cover tape has no spliced point.
- (5) Missing components number  
Missing components number within 0.1 % of the number per reel or 1 pc., whichever is greater, and are not continuous. The specified quantity per reel is kept.

9.3 Pull Strength

Embossed carrier tape	9.8N min.
Cover tape	10N min.

9.4 Peeling off force of cover tape

Speed of Peeling off	300mm/min
Peeling off force	0.1 to 0.7N (minimum value is typical)

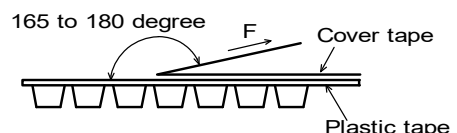

9.5 Dimensions of Leader-tape, Trailer and Reel

There shall be leader-tape(cover tape) and trailer-tape (empty tape) as follows.

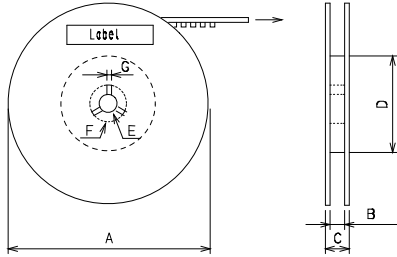
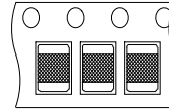
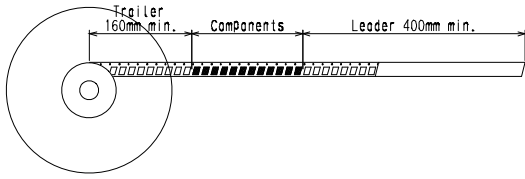

(単位 mm)

A	$\phi 180 \pm 0$
B	$9 \pm 0.3$
C	$11.4 \pm 1$
D	$\phi 60 \pm 1$
E	$\phi 13 \pm 0.2$
F	$\phi 21 \pm 0.8$
G	$2.0 \pm 0.5$

9.6 Marking for reel

Customer part number, MURATA part number, Inspection number(\*1), RoHS marking(\*2), Quantity etc ...

\*1) <Expression of Inspection No.> □□ OOOO XXX  
 (1) (2) (3)

(1) Factory Code

(2) Date

First digit : Year / Last digit of year

Second digit : Month / Jan. to Sep. → 1 to 9, Oct. to Dec. → O, N, D

Third, Fourth digit : Day

(3) Serial No.

\*2) « Expression of RoHS marking » ROHS -  $\frac{Y}{(1) (2)}$  ( $\Delta$ )

(1) RoHS regulation conformity

(2) MURATA classification number

9.7 Marking for Outside package (corrugated paper box)

Customer name, Purchasing order number, Customer part number, MURATA part number, RoHS marking (\*2), Quantity, etc ...

10.8. Specification of Outer Case

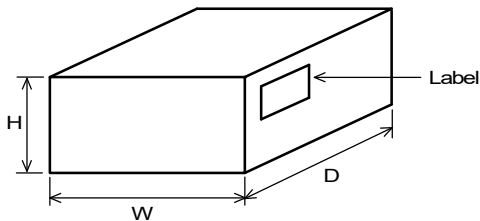

Outer Case Dimensions (mm)			Standard Reel Quantity in Outer Case (Reel)
W	D	H	
186	186	93	5

Above Outer Case size is typical. It depends on a quantity of an order.

10. **Caution**

Limitation of Applications

Please contact us before using our products for the applications listed below which require especially high reliability for the prevention of defects which might directly cause damage to the third party's life, body or property.

- |   |   |
|---|---|
| (1) Aircraft equipment<br>(2) Aerospace equipment<br>(3) Undersea equipment<br>(4) Power plant control equipment<br>(5) Medical equipment | (6) Transportation equipment (vehicles, trains, ships, etc.)<br>(7) Traffic signal equipment<br>(8) Disaster prevention / crime prevention equipment<br>(9) Data-processing equipment<br>(10) Applications of similar complexity and /or reliability requirements to the applications listed in the above |
|---|---|

**11. Notice**

This product is designed for solder mounting.

Please consult us in advance for applying other mounting method such as conductive adhesive.

This product employs a core with low insulation resistance, Pay strict attention when use it.

- a) Do not make any through holes and copper pattern under the coil except a copper pattern to the electrode.
- b) Design/mount any components not to contact this product.

**11.1 Land pattern designing (Reflow Soldering)**

Recommended land pattern for reflow soldering is as follows:

It has been designed for Electric characteristics and solderability.

Please follow the recommended patterns. Otherwise, their performance which includes electrical performance or solderability may be affected, or result to "position shift" in soldering process.

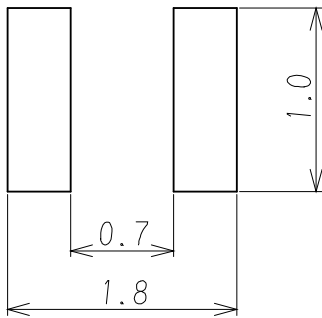

(in mm)

**11.2 Flux, Solder**

Flux	<ul style="list-style-type: none"> <li>• Use rosin-based flux.</li> <li>• Don't use highly acidic flux with halide content exceeding 0.2(wt)% (chlorine conversion value).</li> <li>• Don't use water-soluble flux.</li> </ul>
Solder	<ul style="list-style-type: none"> <li>• Use Sn-3.0Ag-0.5Cu solder</li> <li>• Standard thickness of solder paste : 100µm to 150µm</li> </ul>

Other flux (except above) Please contact us for details, then use.

**11.3 soldering conditions (Reflow)**

- Pre-heating should be in such a way that the temperature difference between solder and product surface is limited to 100°C max. Cooling into solvent after soldering also should be in such a way that the temperature difference is limited to 100°C max. Insufficient pre-heating may cause cracks on the product, resulting in the deterioration of product quality.
- Standard soldering profile is as follows.

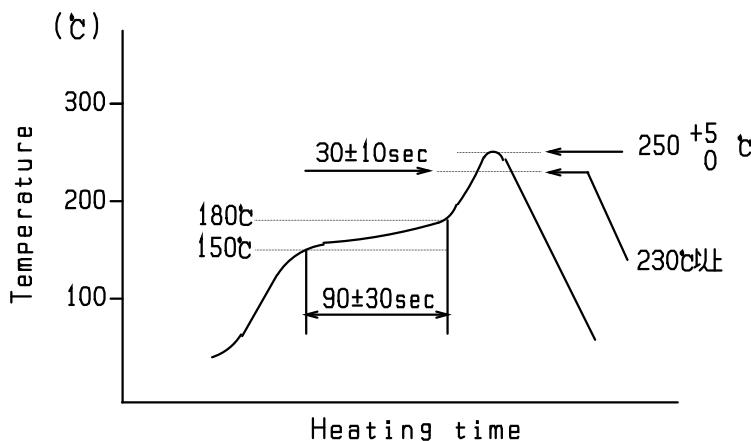

Standard Profile	
Pre-heating	150°C~180°C 、90s±30s
Heating	above 230°C 、20s~40s
Peak temperature	250+5/-0°C
Cycle of reflow	2 times

11.4 Solder Volume

- Solder shall be used not to be exceeded the upper limits as shown below.
- Accordingly increasing the solder volume, the mechanical stress to Chip is also increased. Exceeding solder volume may cause the failure of mechanical or electrical performance.

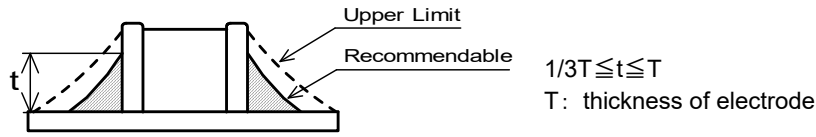

11.5 Product's location

The following shall be considered when designing and laying out P.C.B.'s.

- (1) P.C.B. shall be designed so that products are not subject to the mechanical stress due to warping the board.

[Products direction]

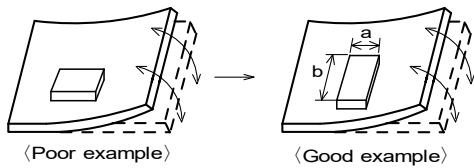

Products shall be located in the sideways direction to the mechanical stress.

- (2) Components location on P.C.B. separation.

It is effective to implement the following measures, to reduce stress in separating the board. It is best to implement all of the following three measures; however, implement as many measures as possible to reduce stress.

Contents of Measures	Stress Level
(1) Turn the mounting direction of the component parallel to the board separation surface.	A > D *1
(2) Add slits in the board separation part.	A > B
(3) Keep the mounting position of the component away from the board separation surface.	A > C

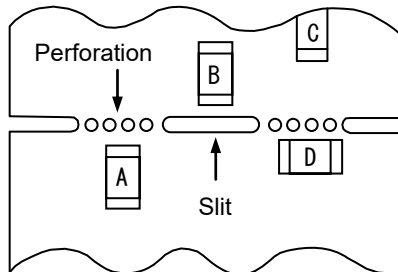

\*1 A > D is valid when stress is added vertically to the perforation as with Hand Separation. If a Cutting Disc is used, stress will be diagonal to the PCB, therefore A > D is invalid.

- (3) Mounting Components Near Screw Holes

When a component is mounted near a screw hole, it may be affected by the board deflection that occurs during the tightening of the screw. Mount the component in a position as far away from the screw holes as possible.

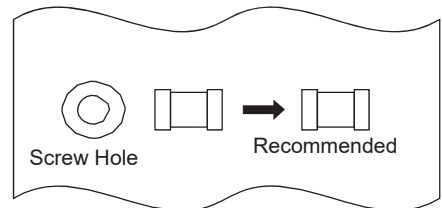

11.6 Resin coating

The inductance value may change and/or it may affect on the product's performance due to high cure-stress of resin to be used for coating/molding products. So please pay your careful attention when you select resin. In prior to use, please make the reliability evaluation with the product mounted in your application set.

11.7 Temperature rating of the circuit board and components located around

Temperature may rise up to max. 40 °C when applying the rated current to the Products. Be careful of the temperature rating of the circuit board and components located around.

11.8 Caution for use

There is possibility that the inductance value change due to magnetism. Don't use a magnet or a pair of tweezers with magnetism when chip coil are handled. (The tip of the tweezers should be molded with resin or pottery.)

### 11.9 Magnetic Saturation

When the excessive current over rated current is applied, the inductance value may change due to magnetism.

### 11.10 Handling of a substrate

After mounting products on a substrate, do not apply any stress to the product caused by bending or twisting to the substrate when cropping the substrate, inserting and removing a connector from the substrate or tightening screw to the substrate.

Excessive mechanical stress may cause cracking in the product.

#### Bending

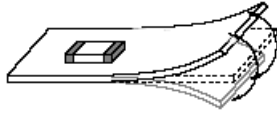

#### Twisting

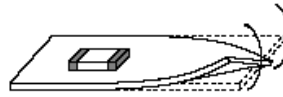

### 11.11 Storage and Handling Requirements

#### (1) Storage period

Use the products within 6 months after delivered.

Solderability should be checked if this period is exceeded.

#### (2) Storage conditions

•Products should be stored in the warehouse on the following conditions.

Temperature : -10°C to 40°C

Humidity : 15% to 85% relative humidity No rapid change on temperature and humidity

Don't keep products in corrosive gases such as sulfur, chlorine gas or acid, or it may cause oxidization of electrode, resulting in poor solderability.

•Products should be stored on the palette for the prevention of the influence from humidity, dust and so on.

•Products should be stored in the warehouse without heat shock, vibration, direct sunlight and so on.

•Products should be stored under the airtight packaged condition.

#### (3) Handling Condition

Care should be taken when transporting or handling product to avoid excessive vibration or mechanical shock.

## 12. Note

(1) Please make sure that your product has been evaluated in view of your specifications with our product being mounted to your product.

(2) You are requested not to use our product deviating from the reference specifications.

(3) The contents of this reference specification are subject to change without advance notice.

Please approve our product specifications or transact the approval sheet for product specifications before ordering.