

BWVN Series



BWVN series, an automatic assembly power inductor, is suitable for the portable DC-DC converter application.

Features

- RoHS compliant
- Highly accurate dimensions can be mounted automatically
- Terminals are highly resistant to pull forces.
- Highly reliable in environments of sudden temperature change

Applications

- Portable equipment such as, PDA,MP3,HDD, Mobil phone, DSC etc.
- Game Console.
- DC / DC converters.

Product Identification

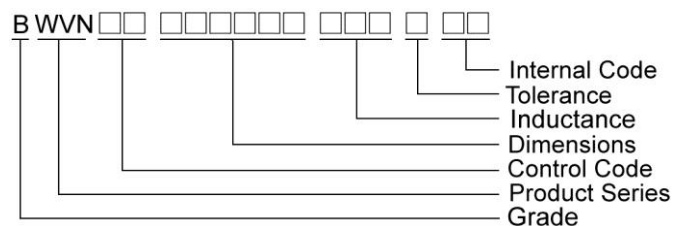

Shapes and Dimensions

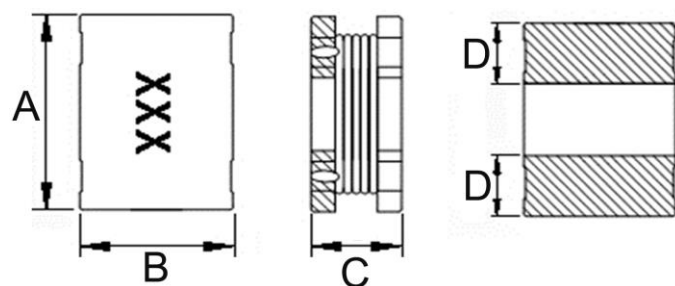

Recommended Pattern

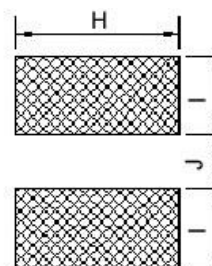

Dimensions in mm

TYPE	A	B	C	D	H	I	J
BWVN00322515	3.2±0.2	2.5±0.2	1.5±0.2	1.0	2.6	1.2	1.0

SMD Unshielded Power Inductors - BWVN Series

Electrical Characteristics

Part Number	Inductance (uH)	Tolerance (±%)	Test Frequency (MHz)	RDC (Ω) ±20%	Isat (A)Max	Irms (A)Max	Marking
BWVN00322515R47□00	0.47	30	1	0.030	3.40	2.55	R47
BWVN003225151R0□00	1.0	30	1	0.045	2.30	2.05	1R0
BWVN003225151R5□00	1.5	30	1	0.057	1.75	1.75	1R5
BWVN003225152R2□00	2.2	20, 30	1	0.076	1.55	1.60	2R2
BWVN003225153R3□00	3.3	20, 30	1	0.12	1.25	1.20	3R3
BWVN003225154R7□00	4.7	20, 30	1	0.18	1.00	1.00	4R7
BWVN003225156R8□00	6.8	20, 30	1	0.24	0.85	0.85	6R8
BWVN00322515100□00	10	20, 30	1	0.38	0.75	0.70	100
BWVN00322515150□00	15	20, 30	1	0.70	0.55	0.50	150
BWVN00322515220□00	22	20, 30	1	0.81	0.50	0.45	220
BWVN00322515330□00	33	20, 30	1	1.05	0.36	0.32	330
BWVN00322515470□00	47	20, 30	1	1.48	0.28	0.24	470

Note: When ordering, please specify tolerance code. Tolerance: M=±20% , T =±30%

- Operating temperature range - 40°C ~ 125°C(Including self - temperature rise)
- Isat for Inductance drop 30% from its value without current
- I rms for a 40°C temperature rise from 25°C ambient with current
- Measure Equipment :
- L : Agilent/HP4287A+ Agilent/HP16197A, 1MHz 200mV
- RDC : DIGITAL MILLINHM METER CHROMA 16502, or equivalent
- Isat & I rms : Agilent HP4284A

Test Instruments : HP4287A Material/Impedance Analyzer

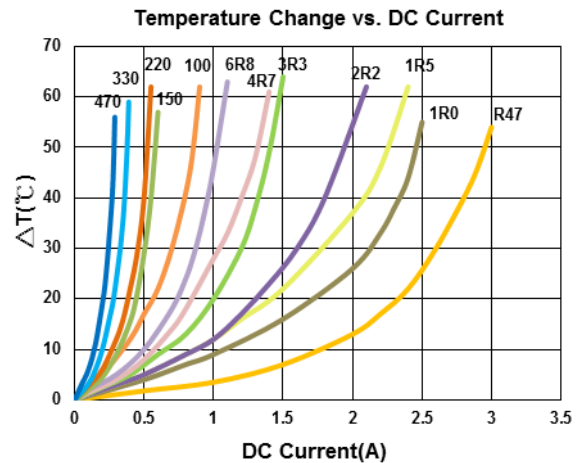
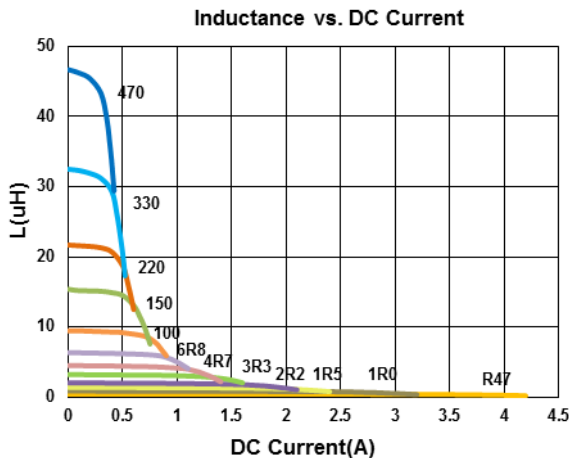

SMD Unshielded Power Inductors - BWVN Series

Packaging Specifications

Tape Dimensions

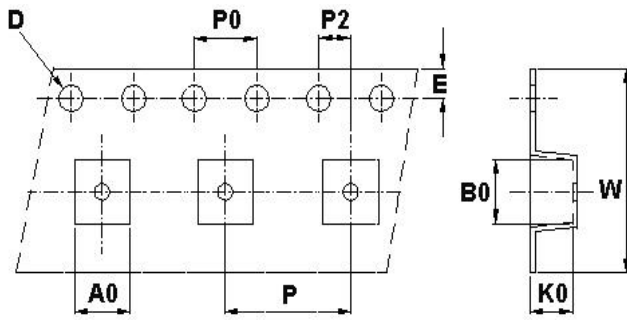

Reel Dimensions

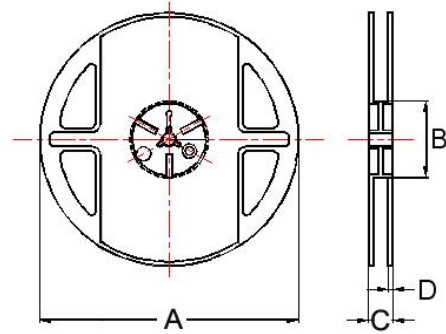

Dimensions in mm

TYPE	Tape Dimensions									Reel Dimensions				Quantity
	A0	B0	K0	D	E	W	P	P0	P2	A	B	C	D	PCS / Reel
BWVN00322515	2.85	3.56	1.80	1.55	1.75	8	4	4	2	178	60	9	1.5	800