

For the electronic measurement of current: DC, AC, pulsed..., with galvanic separation between the primary and the secondary circuit.

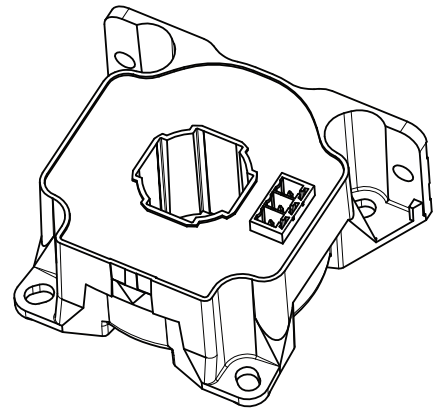

### Features

- Bipolar and insulated current measurement
- Current output
- Closed loop (compensated) current transducer
- Panel mounting.

### Special feature

- Connection to secondary circuit on three-pole connector, Phoenix/Enterlec compatible.

### Advantages

- High accuracy
- Very low offset drift over temperature.

### Applications

- Windmill inverters
- Test measurement
- Substations
- AC variable speed and servo motor drives
- Static converters for DC motor drives
- Battery supplied applications
- Uninterruptible Power Supplies (UPS)
- Switched Mode Power Supplies (SMPS)
- Power supplies for welding applications.

### Standards

- IEC 61010-1: 2010
- IEC 61800-5-1: 2007
- IEC 62109-1: 2010
- UL 508: 2013.

### Application Domain

- Industrial.

## Absolute maximum ratings

Parameter	Symbol	Unit	Value
Maximum supply voltage (working) (−40 ... 85 °C)	$\pm U_{C \max}$	V	±21
Maximum primary conductor temperature	$T_{B \max}$	°C	100
Maximum steady state primary current (−40 ... 85 °C)	$I_{P N \max}$	A	300

Stresses above these ratings may cause permanent damage.  
Exposure to absolute maximum ratings for extended periods may degrade reliability.

## UL 508: Ratings and assumptions of certification

File # E189713 Volume: 2 Section: 9.

### Standards

- USR indicates investigation to the Standard for Industrial Control Equipment UL 508.
- CNR indicates investigation to the Canadian standard for Industrial Control Equipment CSA C22.2 No. 14-13.

### Ratings

Parameter	Unit	Value
Primary involved potential	V AC/DC	1500
Ambient operating temperature	°C	85
Primary current	A	0 ... 300
Secondary supply voltage	V DC	0 ... ±21
Secondary current	mA	0 ... 150

### Conditions of acceptability

When installed in the end-use equipment, with primary feedthrough potential involved of 1500 V AC/DC, consideration shall be given to the following:

- 1 - *These products must be mounted in a suitable end-use enclosure.*
- 2 - *The secondary pin terminals have not been evaluated for field wiring.*
- 3 - *Low voltage control circuit shall be supplied by an isolating source (such as transformer, optical isolator, limiting impedance or electro-mechanical relay).*
- 4 - *Based on the temperature test performed on all Series, the primary bar or conductor shall not exceed 100 °C in the end use application.*
- 5 - *LF310-S series shall be used in a pollution degree 2.*

### Marking

Only those products bearing the UL or UR Mark should be considered to be Listed or Recognized and covered under UL's Follow-Up Service. Always look for the Mark on the product.

**Insulation coordination**

Parameter	Symbol	Unit	Value	Comment
RMS voltage for AC insulation test, 50 Hz, 1 min	$U_d$	kV	3	Type test
Impulse withstand voltage 1.2/50 $\mu$ s	$U_{Ni}$	kV	8	According to IEC 61800-5-1
Partial discharge RMS test voltage ( $q_m \leq 10$ pC)	$U_t$	kV	1.65	Test carried out with a non insulated bar and completely filling the primary hole. According to IEC 61800-5-1
Clearance (pri. -sec.)	$d_{Cl}$	mm	8.6	Shortest distance through air
Creepage distance (pri. -sec.)	$d_{Cp}$	mm	18.9	Shortest path along device body
Application example Rated insulation RMS voltage	$U_{Nm}$	V	1000	Basic insulation according to IEC 61800-5-1 CAT III, PD 2
Application example Rated insulation RMS voltage	$U_{Nm}$	V	600	Reinforced insulation according to IEC 61800-5-1 CAT III, PD 2
Case material	-	-	V0	According to UL 94
Comparative tracking index	$CTI$		600	

**Environmental and mechanical characteristics**

Parameter	Symbol	Unit	Min	Typ	Max	Comment
Ambient operating temperature	$T_A$	$^{\circ}$ C	-40		85	
Ambient storage temperature	$T_{A\ st}$	$^{\circ}$ C	-50		90	
Mass	$m$	g		100		

## Electrical data

At  $T_A = 25\text{ °C}$ ,  $\pm U_C = \pm 15\text{ V}$ ,  $R_M = 1\ \Omega$ , unless otherwise noted.

Lines with a \* in the conditions column apply over the  $-40 \dots 85\text{ °C}$  ambient temperature range.

Parameter	Symbol	Unit	Min	Typ	Max	Conditions
Primary nominal RMS current	$I_{PN}$	A			300	*
Primary current, measuring range	$I_{PM}$	A	-500		500	*
Measuring resistance	$R_M$	$\Omega$	0			* Max value of $R_M$ is given in Figure 1
Secondary nominal RMS current	$I_{SN}$	A	-0.15		0.15	*
Resistance of secondary winding	$R_S$	$\Omega$			22.5	$R_S(T_A) = R_S \times (1 + 0.004 \times (T_A + \Delta\text{temp} - 25))$ Estimated temperature increase @ $I_{PN}$ is $\Delta\text{temp} = 15\text{ °C}$
Secondary current	$I_S$	A	-0.25		0.25	*
Number of secondary turns	$N_S$			2000		
Nominal sensitivity	$S_N$	mA/A		0.5		
Supply voltage	$\pm U_C$	V	$\pm 11.4$		$\pm 21$	*
Current consumption at $I_P = 0\text{ V}$	$I_C$	mA		$33 + I_S$ $35 + I_S$ $38 + I_S$		$\pm U_C = \pm 12\text{ V}$ $\pm U_C = \pm 15\text{ V}$ $\pm U_C = \pm 20\text{ V}$
Offset current, referred to primary	$I_O$	A	-0.2		0.2	
Temperature variation of $I_O$ referred to primary	$I_{OT}$	A	-0.2		0.2	*
Magnetic offset current after $3 \times I_{PN}$ referred to primary	$I_{OM}$	A		$\pm 0.2$		
Sensitivity error	$\varepsilon_S$	%	-0.1		0.1	*
Linearity error	$\varepsilon_L$	% of $I_{PN}$	-0.05		0.05	*
Total error at $I_{PN}$	$\varepsilon_{tot}$	% of $I_{PN}$	-0.2 -0.2		0.2 0.2	25 ... 85 °C * -40 ... 85 °C
RMS noise current referred to primary	$I_{no}$	mA		35		1 Hz to 100 kHz (see Figure 4)
Delay time to 10 % of the final output value $I_{PN}$ step	$t_{D10}$	$\mu\text{s}$		0.5		0 to 300 A, 100 A/ $\mu\text{s}$ $R_M = 10\ \Omega$
Delay time to 90 % of the final output value $I_{PN}$ step	$t_{D90}$	$\mu\text{s}$		0.5		0 to 300 A, 100 A/ $\mu\text{s}$ $R_M = 10\ \Omega$ (see Figure 2)
Frequency bandwidth	$BW$	kHz		100		$R_M = 50\ \Omega$ ; -3 dB

## Definition of typical, minimum and maximum values

Minimum and maximum values for specified limiting and safety conditions have to be understood as such as well as values shown in “typical” graphs.

On the other hand, measured values are part of a statistical distribution that can be specified by an interval with upper and lower limits and a probability for measured values to lie within this interval.

Unless otherwise stated (e.g. “100 % tested”), the LEM definition for such intervals designated with “min” and “max” is that the probability for values of samples to lie in this interval is 99.73 %.

For a normal (Gaussian) distribution, this corresponds to an interval between -3 sigma and +3 sigma. If “typical” values are not obviously mean or average values, those values are defined to delimit intervals with a probability of 68.27 %, corresponding to an interval between -sigma and +sigma for a normal distribution.

Typical, maximal and minimal values are determined during the initial characterization of a product.

Typical performance characteristics

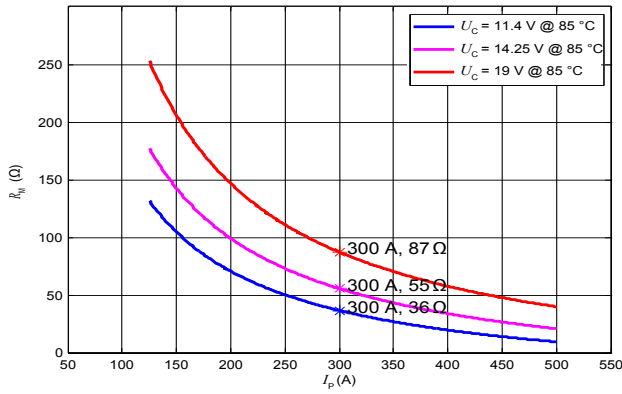

Figure 1: Maximum measuring resistance

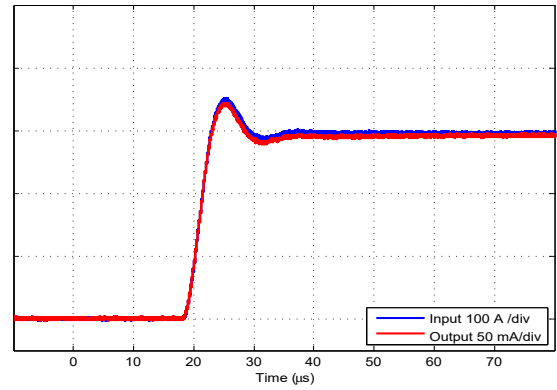

Figure 2: Typical delay time (0 to 300 A, 100 A/μs  $R_M = 10 \Omega$ )

$$R_{M \max} = N_s \times \frac{U_{C \min} - 1.2 \text{ V}}{I_p} - R_{S \max} - 2.4 \Omega$$

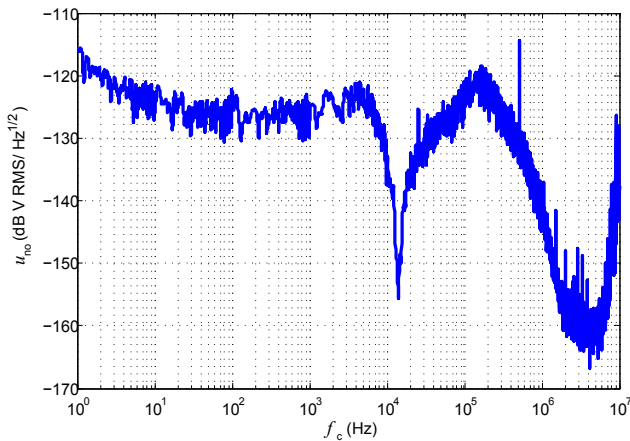

Figure 3: Typical noise voltage spectral density referred to primary  $u_{no}$  with  $R_M = 10 \Omega$

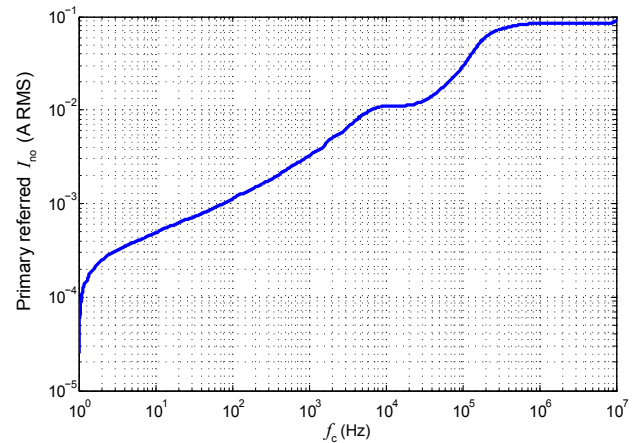

Figure 4: Typical RMS noise current referred to primary  $I_{no}$  with  $R_M = 10 \Omega$

To calculate the noise in a frequency band  $f_1$  to  $f_2$ , the formula is:

$$I_{no}(f_1 \text{ to } f_2) = \sqrt{I_{no}(f_2)^2 - I_{no}(f_1)^2}$$

with  $I_{no}(f)$  read from Figure 4 (typical, RMS value).

Example:

What is the noise from  $10^3$  to  $10^6$  Hz?

Figure 4 gives  $I_{no}(10^3 \text{ Hz}) = 3.19 \text{ mA}$

and  $I_{no}(10^6 \text{ Hz}) = 84.4 \text{ mA}$ .

The output RMS noise current is therefore:

$$\sqrt{(84.4 \times 10^{-3})^2 - (3.19 \times 10^{-3})^2} = 84.34 \text{ mA referred to primary}$$

Typical performance characteristics continued

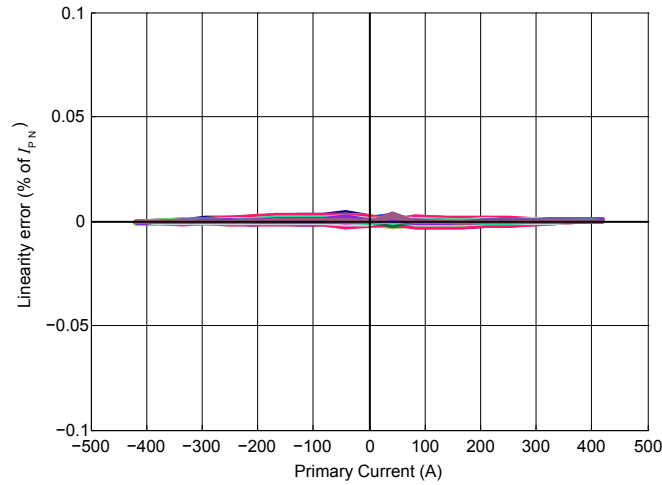

Figure 5: Linearity

Performance parameters definition

Sensitivity and linearity

To measure sensitivity and linearity, the primary current (DC) is cycled from 0 to  $I_{PM}$ , then to  $-I_{PM}$  and back to 0 (equally spaced  $I_{PM}/10$  steps).

The sensitivity  $S$  is defined as the slope of the linear regression line for a cycle between  $\pm I_{PM}$ .

The linearity error  $\epsilon_L$  is the maximum positive or negative difference between the measured points and the linear regression line, expressed in % of the maximum measured value.

Magnetic offset

The magnetic offset  $I_{OM}$  is the change of offset after a given current has been applied to the input. It is included in the linearity error as long as the transducer remains in its measuring range.

Electrical offset

The electrical offset current  $I_{OE}$  is the residual output current when the input current is zero.

Total error

The total error  $\epsilon_{tot}$  is the error at  $\pm I_{PN}$ , relative to the rated value  $I_{PN}$ . It includes all errors mentioned above.

Delay times

The delay time  $t_{D10}$  @ 10 % and the delay time  $t_{D90}$  @ 90 % with respect to the primary are shown in the next figure.

Both slightly depend on the primary current  $di/dt$ . They are measured at nominal current.

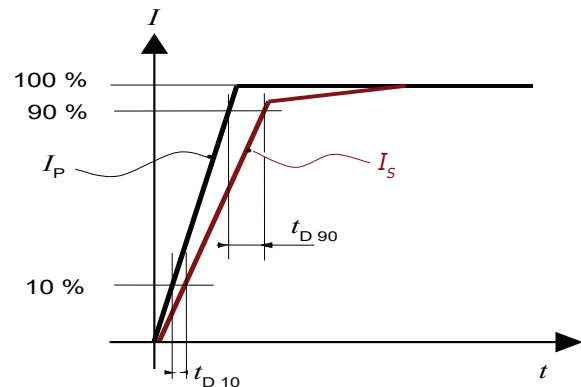
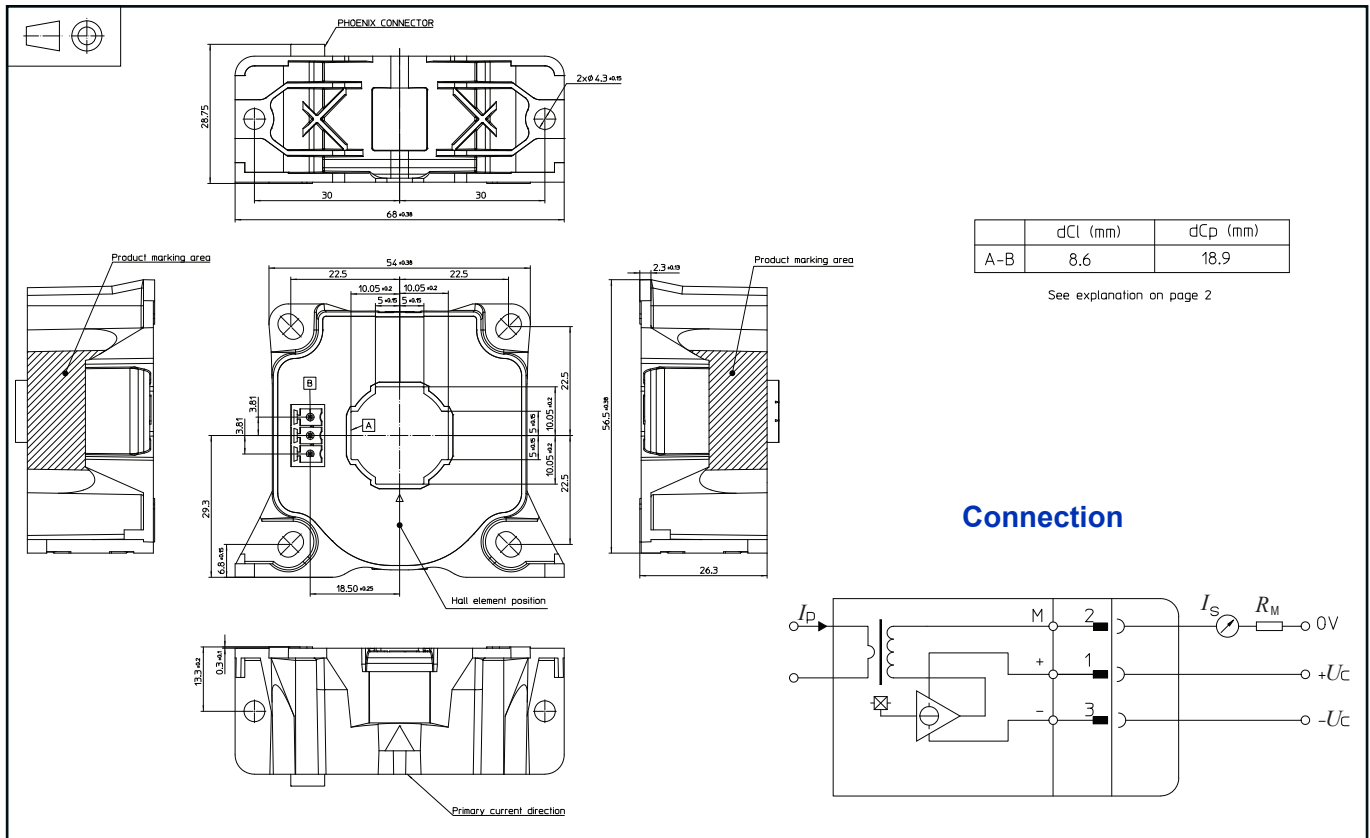

Figure 6:  $t_{D10}$  (delay time @ 10 %) and  $t_{D90}$  (delay time @ 90 %)

**Dimensions** (in mm)



**Mechanical characteristics**

- General tolerance  $\pm 0.3$  mm
- Transducer fastening
  - Vertical position
    - 2 holes  $\varnothing 4.3$  mm
    - 2 M4 steel screws
    - Recommended fastening torque 2.1 N·m ( $\pm 10$  %)
  - Horizontal position
    - 4 holes  $\varnothing 4.3$  mm
    - 4 M4 steel screws
    - Recommended fastening torque 2.1 N·m ( $\pm 10$  %)
- Connection of secondary
  - Phoenix/Entrelec three-pole connector with 3.81 mm pitch
  - Primary through hole  $\varnothing 20$  mm

**Remarks**

- $I_s$  is positive when  $I_p$  flows in the direction of arrow.
- The secondary cables also have to be routed together all the way.
- Installation of the transducer is to be done without primary current or secondary voltage present.
- Maximum temperature of primary conductor: see page 2.
- Installation of the transducer must be done unless otherwise specified on the datasheet, according to LEM Transducer Generic Mounting Rules. Please refer to LEM document N°ANE120504 available on our Web site: <https://www.lem.com/en/file/3137/download>.

**Safety**

This transducer must be used in limited-energy secondary circuits according to IEC 61010-1.



This transducer must be used in electric/electronic equipment with respect to applicable standards and safety requirements in accordance with the manufacturer's operating instructions.



Caution, risk of electrical shock

When operating the transducer, certain parts of the module can carry hazardous voltage (eg. primary connection, power supply).

Ignoring this warning can lead to injury and/or cause serious damage.

This transducer is a build-in device, whose conducting parts must be inaccessible after installation.

A protective housing or additional shield could be used. Main supply must be able to be disconnected.