

Gas Discharge Tube (GDT) Data Sheet

Features

- Provide ultra-fast response to surge voltage from slow-rising surge of 100V/s to rapid-rising surge of 1KV/μs
- Stable breakdown voltage
- High insulation resistance
- Low capacitance (≤1.5pF)
- High holdover voltage
- Large absorbing transient current capability
- Micro-Gap Design
- Size: 8.0mm*6.0mm
- Storage and operating temperature: -40°C ~ +85°C
- Meets MSL level 1, per J-STD-020
- Safety certification: UL E244458



Applications

- Repeaters, Modems
- Telephone Interface, Line cards
- Data communication equipment
- Line test equipment

Part Number Code

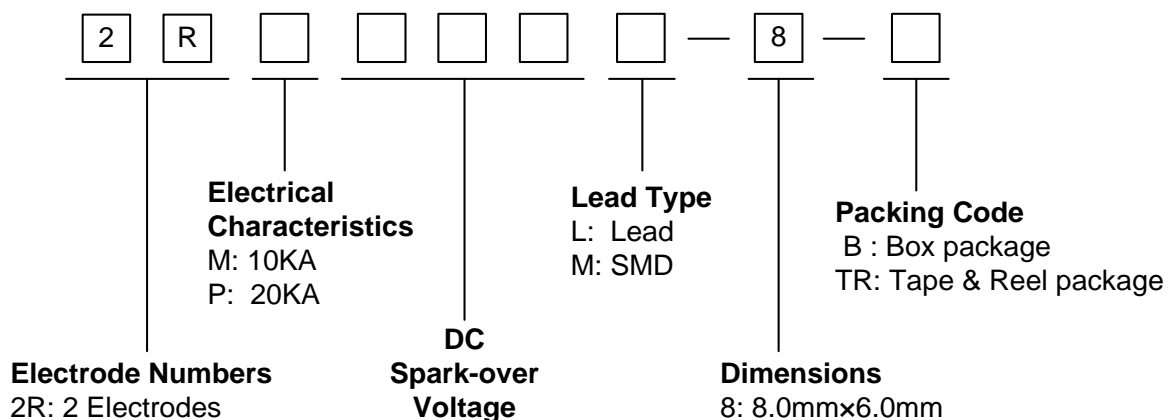

Ordering Code for different package in 2RMxxxL-8 and 2RPxxxL-8 series

Box package: Add suffix “/B” at the end of the part number, such as 2RM075L-8/B or 2RP075L-8/B
 Tape & Reel package: Add suffix “/TR” at the end of the part number, such as 2RM075L-8/TR or 2RP075L-8/TR

Marking

B : BritghtKing Logo
 2RM090-8 : Device Marking Code
 XXXX : Internal Control Code

Dimensions

L Type	Symbol	Dimension (mm)	
		Spec.	Tolerance
	D	8.0	+0.3, -0.5
	T	6.0	+0.3, -0.5
	d	0.8	±0.1
	L	30.0	Max.
M Type	D	8.0	+0.3, -0.5
	B	0.5	±0.1

Note: M Type diagram shows dimensions B, T, D, and a Recommended Pad Size of 6.0 x 8.0 with a 1.5 offset.

Electrical Characteristics

Part Number	DC Spark-over Voltage	Maximum Impulse Spark-over Voltage	Nominal Impulse Discharge Current	Alternating Discharge Current	Impulse Life	Minimum Insulation Resistance		Maximum Capacitance	Device Marking Code	
						Test Voltage	(GΩ)			
						(V)	(pF)			
2RM075L-8	2RM075M-8	75±20%	600	10	10	500	25	1.0	1.5	2RM075-8
2RM090L-8	2RM090M-8	90±20%	600	10	10	500	50	1.0	1.5	2RM090-8
2RM120L-8	2RM120M-8	120±20%	600	10	10	500	50	1.0	1.5	2RM120-8
2RM145L-8	2RM145M-8	145±20%	700	10	10	500	100	1.0	1.5	2RM145-8
2RM150L-8	2RM150M-8	150±20%	700	10	10	500	100	1.0	1.5	2RM150-8
2RM230L-8	2RM230M-8	230±20%	700	10	10	500	100	1.0	1.5	2RM230-8
2RM250L-8	2RM250M-8	250±20%	800	10	10	500	100	1.0	1.5	2RM250-8
2RM300L-8	2RM300M-8	300±20%	900	10	10	500	100	1.0	1.5	2RM300-8
2RM350L-8	2RM350M-8	350±20%	900	10	10	500	100	1.0	1.5	2RM350-8
2RM400L-8	2RM400M-8	400±20%	1000	10	10	500	100	1.0	1.5	2RM400-8
2RM470L-8	2RM470M-8	470±20%	1100	10	10	500	250	1.0	1.5	2RM470-8
2RM600L-8	2RM600M-8	600±20%	1300	10	10	500	250	1.0	1.5	2RM600-8
2RM800L-8	2RM800M-8	800±20%	1500	10	10	500	250	1.0	1.5	2RM800-8

Electrical Characteristics

Part Number		DC Spark-over Voltage	Maximum Impulse Spark-over Voltage	Nominal Impulse Discharge Current	Alternating Discharge Current	Impulse Life	Minimum Insulation Resistance		Maximum Capacitance	Device Marking Code
		100V/s	1000V/ μ s	8/20 μ s 10times	50Hz, 1sec	10/1000 μ s 100A	Test Voltage	(G Ω)	1MHz	
		(V)	(V)	(KA)	(A)	(times)	DC(V)		(pF)	
2RP075L-8	2RP075M-8	75 \pm 20%	600	20	20	500	25	1.0	1.5	2RP075-8
2RP090L-8	2RP090M-8	90 \pm 20%	600	20	20	500	50	1.0	1.5	2RP090-8
2RP120L-8	2RP120M-8	120 \pm 20%	600	20	20	500	50	1.0	1.5	2RP120-8
2RP145L-8	2RP145M-8	145 \pm 20%	700	20	20	500	100	1.0	1.5	2RP145-8
2RP150L-8	2RP150M-8	150 \pm 20%	700	20	20	500	100	1.0	1.5	2RP150-8
2RP230L-8	2RP230M-8	230 \pm 20%	700	20	20	500	100	1.0	1.5	2RP230-8
2RP250L-8	2RP250M-8	250 \pm 20%	800	20	20	500	100	1.0	1.5	2RP250-8
2RP300L-8	2RP300M-8	300 \pm 20%	900	20	20	500	100	1.0	1.5	2RP300-8
2RP350L-8	2RP350M-8	350 \pm 20%	900	20	20	500	100	1.0	1.5	2RP350-8
2RP400L-8	2RP400M-8	400 \pm 20%	1000	20	20	500	100	1.0	1.5	2RP400-8
2RP470L-8	2RP470M-8	470 \pm 20%	1100	20	20	500	250	1.0	1.5	2RP470-8
2RP600L-8	2RP600M-8	600 \pm 20%	1300	20	20	500	250	1.0	1.5	2RP600-8
2RP800L-8	2RP800M-8	800 \pm 20%	1500	20	20	500	250	1.0	1.5	2RP800-8

Electrical Ratings

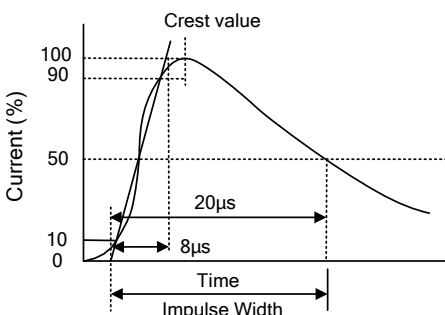
Items	Test Condition/Description	Requirement
DC Spark-over Voltage	The voltage is measured with voltage ramp $dv/dt=100V/s$.	
Maximum Impulse Spark-over Voltage	The maximum impulse spark-over voltage is measured with voltage ramp $dv/dt=1000V/\mu s$.	
Impulse Discharge Current	<p>Maximum 8/20μs surge current that can be applied between two electrodes, 5 positive and 5 negative surges, with 3 minutes interval time.</p> 	To meet the specified value
Alternating Discharge Current	Rated RMS value of AC current at 50Hz, 1 sec. for 10 times with interval time 3 min.	
Insulation Resistance	The resistance of gas tube shall be measured between two electrodes.	
Capacitance	The capacitance of gas tube shall be measured between two electrodes. Test frequency: 1MHz	

Recommended Soldering Conditions

Wave Soldering

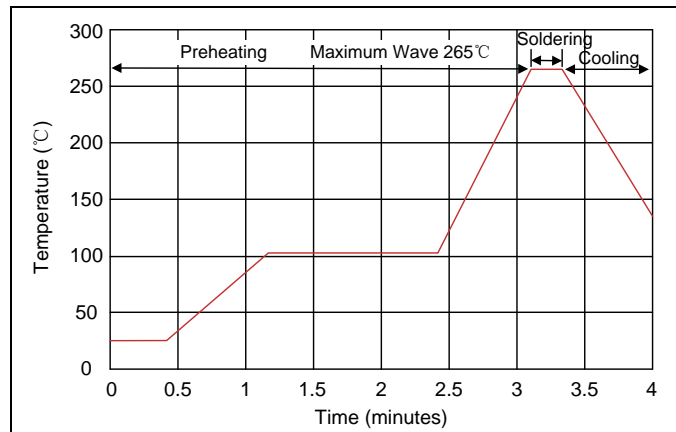

Item	Conditions
Peak Temperature	265°C
Dipping Time	10 seconds
Soldering	1 time

Reflow Soldering

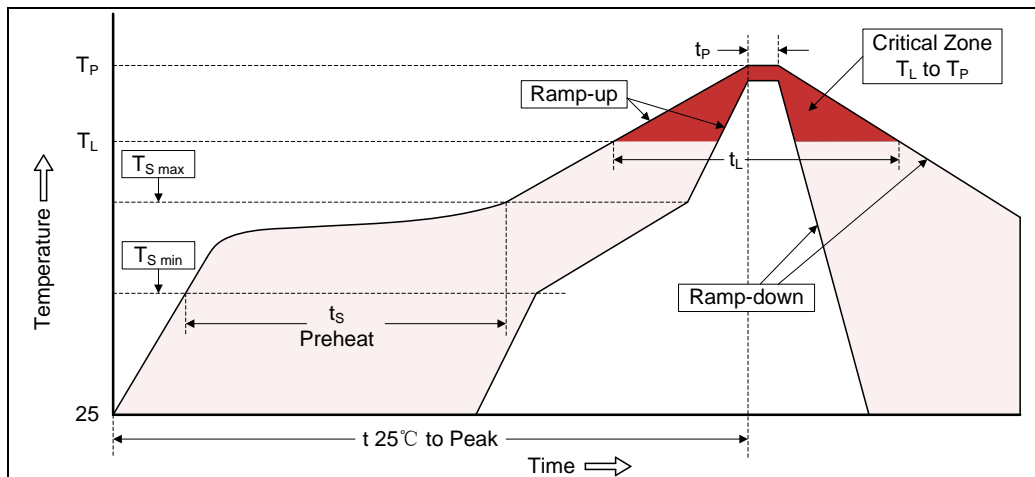

Profile Feature	Pb-Free Assembly
Average ramp-up rate (T _L to T _P)	3°C/second max.
Preheat -Temperature Min (T _{S min}) -Temperature Max (T _{S max}) -Time (min to max) (t _s)	150°C 200°C 60-180 seconds
T _{S max} to T _L -Ramp-up Rate	3°C/second max.
Time maintained above: -Temperature (T _L) -Time (t _L)	217°C 60-150 seconds
Peak Temperature (T _P)	260°C
Time within 5°C of actual Peak Temperature (t _P)	20-40 seconds
Ramp-down Rate	6°C/second max.
Time 25°C to Peak Temperature	8 minutes max.

Packaging

Axial Packing (Box)

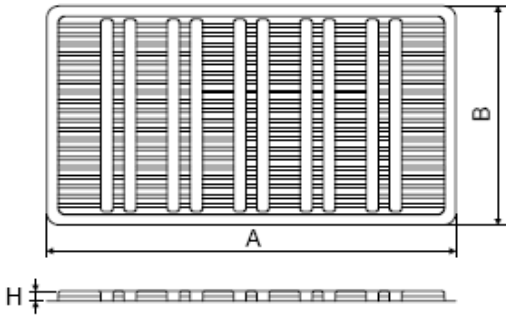
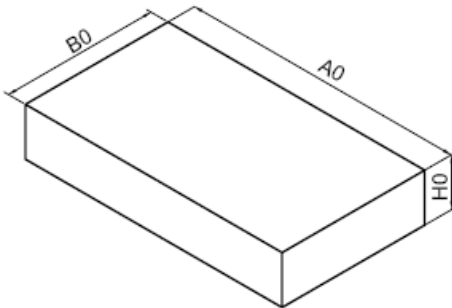
Skin packing		Dimension (mm)		
		Symbol	Spec.	Tolerance
		A	265.0	±5.0
		B	146.0	±5.0
		H	8.5	±0.5
Quantity: 100pcs				
Inner box		A0	270.0	±2.0
		B0	150.0	±2.0
		H0	50.0	±2.0
		Quantity: 500pcs		

Axial Packing (Tape & Reel)

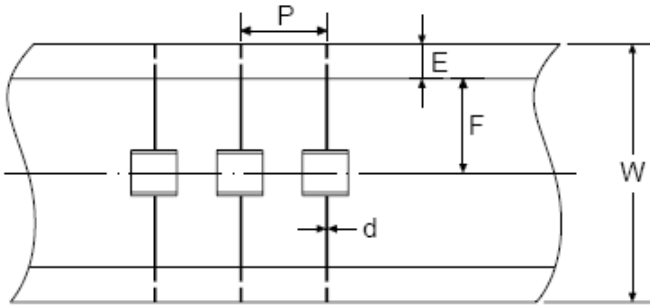
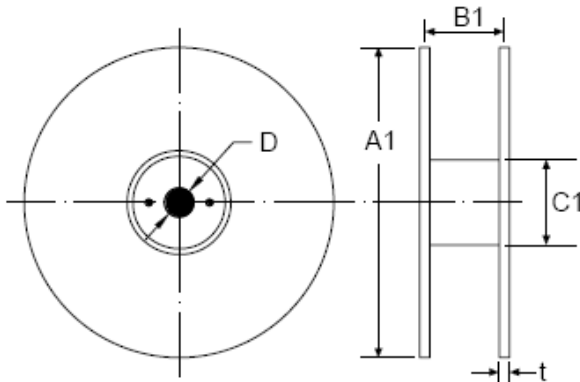
Tape		Dimension (mm)		
		Symbol	Spec.	Tolerance
		P	10.0	±0.5
		W	65.0	±1.0
		E	6.0	±0.5
		F	26.5	±0.5
		d	0.8	±0.1
Reel		A1	330.0	±2.0
		B1	70.0	±2.0
		C1	82.0	±2.0
		D	25.0	±0.5
		t	2.0	±0.2
		Quantity: 500pcs		

SMD Packing (Tape & Reel)

Tape	Symbol	Dimension (mm)	
		Spec.	Tolerance
	W	16.00	±0.20
	P0	4.00	±0.10
	P1	12.00	±0.20
	P2	2.00	±0.10
	D0	1.55	±0.05
	E	1.75	±0.10
	F	7.50	±0.10
	A0	8.20	±0.10
	K0	8.50	±0.10
	B0	7.50	±0.10
	t0	0.50	±0.10
	D	330.00	±2.00
	d	13.00	±0.50
	L	20.00	±2.00
	t	2.00	±0.20
Quantity: 500pcs			

Reel

